

Wall mounted Type

ON/OFF EK-Series

Model No.HSU-18HEK03



WARNING

This service information is designed for experienced repair technicians only and is not designed for use by the general public. It does not contain warnings or cautions to advise non-technical individuals of potential dangers in attempting to service a product. Products powered by electricity should be serviced or repaired only by experienced professional technicians. Any attempt to service or repair the product or products dealt with in this service information by anyone else could result in serious injury or death

© 2010 (Qingdao Haier Air Conditioner General corp.,Ltd)

All right reserved .Unauthorized copying and distribution is a violation of law

Haier Group



Большая библиотека технической документации

<https://splitsystema48.ru/instrukcii-po-ekspluatacii-kondicionerov.html>

каталоги, инструкции, сервисные мануалы, схемы.

Table of Contents

1.Features	1
2.Introduction	2
3. Specifications	7
4. Printed Circuit Board Connector Wiring Diagram	9
5. Functions and Control	10
5.1 Main functions and Control Specification	10
5.2 Value of Thermistor	15
6. System Configuration	23
6.1 System Configuration	23
6.2 Instruction	23
7.Codes and description	32
7.1 Problem Symptoms and Measures	32
7.2 Error Codes and Description indoor display	32
8. Capacity diagrams and curves diagrams	35
9. Installations	45
10. Appendix	45
10.1 Piping diagrams	45
10.2 Wiring diagrams	49
10.3 Circuit diagrams	51
10.4 Dimensional drawings and center of gravity	52
10.5 Operation range	54
10.6 Accesories	54
10.7 Description of the unit model's coding rules	56
11.Removal Procedure	57

1 Features



ESF filter : Trap harmful dust and remove unpleasant odors effectively



4 Fan setting: Slect the fan speed LO,MED,HI,AUTO



Anti-mold filter: Catches most small particles and remove unpleasant odors effectively



Sleep mode: The setting temprature and the indoor noise can be adjusted to a more comfortable level when you set the "sleep mode"during night sleep



24 Hour timer: Use the timer function to set on,or off,or from on to off,or from off to on



Auto restart: The function permits automatic return to previous peration conditions



Easy clean design: The panel is easy to wash and the airflow vents can be detached without any special tools for quick cleaning of the inside of the air conditioner



Auto mode According to the fixed temperature "26°C " ,the unit will adjust the operation mode automatically.

2. Introduction

2.1 Safety Cautions

Be sure to read the following safety cautions before conducting repair work.

The caution items are classified into “Warning” and “Caution”. The “Warning” items are especially important since they can lead to death or serious injury if they are not followed closely. The “Caution” items can also lead to serious accidents under some conditions if they are not followed. Therefore, be sure to observe all the safety caution items described below.

About the pictograms

△ This symbol indicates an item for which caution must be exercised.

The pictogram shows the item to which attention must be paid.

○ This symbol indicates a prohibited action.





The prohibited item or action is shown inside or near the symbol.







● This symbol indicates an action that must be taken, or an instruction.

The instruction is shown inside or near the symbol.

After the repair work is complete, be sure to conduct a test operation to ensure that the equipment operates normally, and explain the cautions for operating the product to the customer.



2.1.1 Caution in Repair

Warning	
<p>Be sure to disconnect the power cable plug from the plug socket before disassembling the equipment for a repair.</p> <p>Working on the equipment that is connected to a power supply can cause an electrical shock.</p> <p>If it is necessary to supply power to the equipment to conduct the repair or inspecting the circuits, do not touch any electrically charged sections of the equipment.</p>	
<p>If the refrigerant gas discharges during the repair work, do not touch the discharging refrigerant gas. The refrigerant gas can cause frostbite.</p>	
<p>When disconnecting the suction or discharge pipe of the compressor at the welded section, release the refrigerant gas completely at a well-ventilated place first.</p> <p>If there is a gas remaining inside the compressor, the refrigerant gas or refrigerating machine oil discharges when the pipe is disconnected, and it can cause injury.</p>	
<p>If the refrigerant gas leaks during the repair work, ventilate the area. The refrigerant gas can generate toxic gases when it contacts flames.</p>	
<p>The step-up capacitor supplies high-voltage electricity to the electrical components of the outdoor unit.</p> <p>Be sure to discharge the capacitor completely before conducting repair work. A charged capacitor can cause an electrical shock.</p>	
<p>Do not start or stop the air conditioner operation by plugging or unplugging the power cable plug.</p> <p>Plugging or unplugging the power cable plug to operate the equipment can cause an electrical shock or fire.</p>	

Warning	
Do not repair the electrical components with wet hands. Working on the equipment with wet hands can cause an electrical shock.	
Do not clean the air conditioner by splashing water. Washing the unit with water can cause an electrical shock.	
Be sure to provide the grounding when repairing the equipment in a humid or wet place, to avoid electrical shocks.	
Be sure to turn off the power switch and unplug the power cable when cleaning the equipment. The internal fan rotates at a high speed, and cause injury.	
Do not tilt the unit when removing it. The water inside the unit can spill and wet the furniture and floor.	
Be sure to check that the refrigerating cycle section has cooled down sufficiently before conducting repair work. Working on the unit when the refrigerating cycle section is hot can cause burns.	
Use the welder in a well-ventilated place. Using the welder in an enclosed room can cause oxygen deficiency.	



2.1.2 Cautions Regarding Products after Repair

Warning	
Be sure to use parts listed in the service parts list of the applicable model and appropriate tools to conduct repair work. Never attempt to modify the equipment. The use of inappropriate parts or tools can cause an electrical shock, excessive heat generation or fire.	
When relocating the equipment, make sure that the new installation site has sufficient strength to withstand the weight of the equipment. If the installation site does not have sufficient strength and if the installation work is not conducted securely, the equipment can fall and cause injury.	
Be sure to install the product correctly by using the provided standard installation frame. Incorrect use of the installation frame and improper installation can cause the equipment to fall, resulting in injury.	For integral units only
Be sure to install the product securely in the installation frame mounted on a window frame. If the unit is not securely mounted, it can fall and cause injury.	For integral units only

Warning	
<p>Be sure to use an exclusive power circuit for the equipment, and follow the technical standards related to the electrical equipment, the internal wiring regulations and the instruction manual for installation when conducting electrical work.</p> <p>Insufficient power circuit capacity and improper electrical work can cause an electrical shock or fire.</p>	
<p>Be sure to use the specified cable to connect between the indoor and outdoor units. Make the connections securely and route the cable properly so that there is no force pulling the cable at the connection terminals.</p> <p>Improper connections can cause excessive heat generation or fire.</p>	
<p>When connecting the cable between the indoor and outdoor units, make sure that the terminal cover does not lift off or dismount because of the cable.</p> <p>If the cover is not mounted properly, the terminal connection section can cause an electrical shock, excessive heat generation or fire.</p>	
<p>Do not damage or modify the power cable.</p> <p>Damaged or modified power cable can cause an electrical shock or fire. Placing heavy items on the power cable, and heating or pulling the power cable can damage the cable.</p>	
<p>Do not mix air or gas other than the specified refrigerant (R-410A / R22) in the refrigerant system.</p> <p>If air enters the refrigerating system, an excessively high pressure results, causing equipment damage and injury.</p>	
<p>If the refrigerant gas leaks, be sure to locate the leak and repair it before charging the refrigerant. After charging refrigerant, make sure that there is no refrigerant leak.</p> <p>If the leak cannot be located and the repair work must be stopped, be sure to perform pump-down and close the service valve, to prevent the refrigerant gas from leaking into the room. The refrigerant gas itself is harmless, but it can generate toxic gases when it contacts flames, such as fan and other heaters, stoves and ranges.</p>	
<p>When replacing the coin battery in the remote controller, be sure to disposed of the old battery to prevent children from swallowing it.</p> <p>If a child swallows the coin battery, see a doctor immediately.</p>	

Caution	
<p>Installation of a leakage breaker is necessary in some cases depending on the conditions of the installation site, to prevent electrical shocks.</p>	
<p>Do not install the equipment in a place where there is a possibility of combustible gas leaks.</p> <p>If a combustible gas leaks and remains around the unit, it can cause a fire.</p>	
<p>Be sure to install the packing and seal on the installation frame properly. If the packing and seal are not installed properly, water can enter the room and wet the furniture and floor.</p>	For integral units only

2.1.3 Inspection after Repair

Warning	
<p>Check to make sure that the power cable plug is not dirty or loose, then insert the plug into a power outlet all the way.</p> <p>If the plug has dust or loose connection, it can cause an electrical shock or fire.</p>	
<p>If the power cable and lead wires have scratches or deteriorated, be sure to replace them.</p> <p>Damaged cable and wires can cause an electrical shock, excessive heat generation or fire.</p>	





Warning	
<p>Do not use a joined power cable or extension cable, or share the same power outlet with other electrical appliances, since it can cause an electrical shock, excessive heat generation or fire.</p>	

Caution	
<p>Check to see if the parts and wires are mounted and connected properly, and if the connections at the soldered or crimped terminals are secure. Improper installation and connections can cause excessive heat generation, fire or an electrical shock.</p>	
<p>If the installation platform or frame has corroded, replace it. Corroded installation platform or frame can cause the unit to fall, resulting in injury.</p>	
<p>Check the grounding, and repair it if the equipment is not properly grounded. Improper grounding can cause an electrical shock.</p>	
<p>Be sure to measure the insulation resistance after the repair, and make sure that the resistance is 1 M ohm or higher.</p> <p>Faulty insulation can cause an electrical shock.</p>	
<p>Be sure to check the drainage of the indoor unit after the repair.</p> <p>Faulty drainage can cause the water to enter the room and wet the furniture and floor.</p>	

2.1.4 Using Icons

Icons are used to attract the attention of the reader to specific information. The meaning of each icon is described in the table below:

2.1.5 Using Icons List

Icon	Type of Information	Description
 Note:	Note	A “note” provides information that is not indispensable, but may nevertheless be valuable to the reader, such as tips and tricks.
 Caution	Caution	A “caution” is used when there is danger that the reader, through incorrect manipulation, may damage equipment, loose data, get an unexpected result or has to restart (part of) a procedure.
 Warning	Warning	A “warning” is used when there is danger of personal injury.
	Reference	A “reference” guides the reader to other places in this binder or in this manual, where he/she will find additional information on a specific topic.

3. Specifications

Model			HSU-18HEK03	
			Cooling	
Capacity Rated	kW		4.8	5.2
	Btu/h		16380	17750
	kcal/h		4128	4472
POWER SUPPLY			VM	
NOMINAL DISTRIBUTION SYSTEM VOLTAGE	Phase		1PH	
	Frequency	HZ	60	
	Voltage	v	220V	
Moisture Removal		L/h	2.0	
Running Current (Rated)		A	8.7	
Power Consumption Rated		W	1900	1900
COP Rated		W/W	2.53	2.74
Piping Connections (external diameter)	Liquid	mm	φ 6.35	
	Gas	mm	φ 12.7	
	Drain	mm	φ 16.0	
Heat Insulation			Both Liquid and Gas Pipes	
Max. Piping Length		m	20	
Max. Level Difference		m	10	
Chargeless		m	5	
Amount of Additional Charge of Refrigerant		g/m	20	
Indoor Unit				
Front Panel Color			White	
Air Flow Rate	m ³ /min(cfm)	H	12.5(441.3)	
		M	11.6(408.6)	
		L	10.6(375.9)	
Fan	Type		Cross Flow Fan	
	Motor Output	W	26	
	Speed	Steps	3 Steps,Auto	
Air Direction Control			Right, Left, Horizontal, Downward	
Air Filter			Removable / Washable / Mildew Proof	
Run current (rated)		A	0.14	
Power consumption		W	31	
Temperature Control			Microcomputer Control	
Dimensions (H×W×D)		mm	938*187*265	
Packaged Dimensions (H×W×D)		mm	1016*304*360	
Weight		kg	10.5	
Gross Weight		kg	12.5	
Operation Sound	H/M/L	dBA	42/39/37	
Sound Power	H(cooling/heating)	dBA	52	

Outdoor Unit			
Casing Color		Ivory white	
Compressor	Type		Hermetic motor compressor
	Model		Rechi 48R473NU+81SH
	Motor Output	W	1900
	Oil Type		SUNISO 4GSD
	Oil Charge	L	0.51
Refrigerant	Model		R22
	Charge	kg	1.54
Air Flow Rate (H/L)	m ³ /min		32.7
	cfm		1153
Fan	Type		Axial fan
	Motor Output	W	30
Runing current (rated)		A	8.5
Power Consumption (rated)		W	1869
Dimensions (H×W×D) (stop valve, and bottom support is not included)		mm	783*255*543
Packaged Dimensions (H×W×D)		mm	930*340*614
Weight		kg	36.5
Gross Weight		kg	40.5
OperationSound	H	dBA	52
Sound Power	H(cooling/heating)	dBA	52

Note: The data are based on the conditions shown in the table below.

Cooling	Heating	Piping Length
Indoor:27°CDB/19°CWB Outdoor: 35°CDB/24°CWB	Indoor: 20°CDB Outdoor:7°CDB/6°CWB	5m

Conversion Formulae
kcal/h=kW×860
Btu/h=kW×3413
cfm=m ³ /min×35.3

4. Printed Circuit Board Connector Wiring Diagram

4.1 Indoor unit

Connectors Indoor PCB

- 1) CN1 connector for transformer input
- 2) CN2 connector for terminal block.
- 3) CN3 connector for transformer output
- 4) CN5" or CN5"(1) connector for up and down step motor.
- 5) CN6 connector for ambient temp. sensor and piping temp. sensor.
- 6) CN7 connector for receiver display.
- 7) CN8 connector for AC fan feedback motor.
- 8) CN9 connector for AC fan motor.

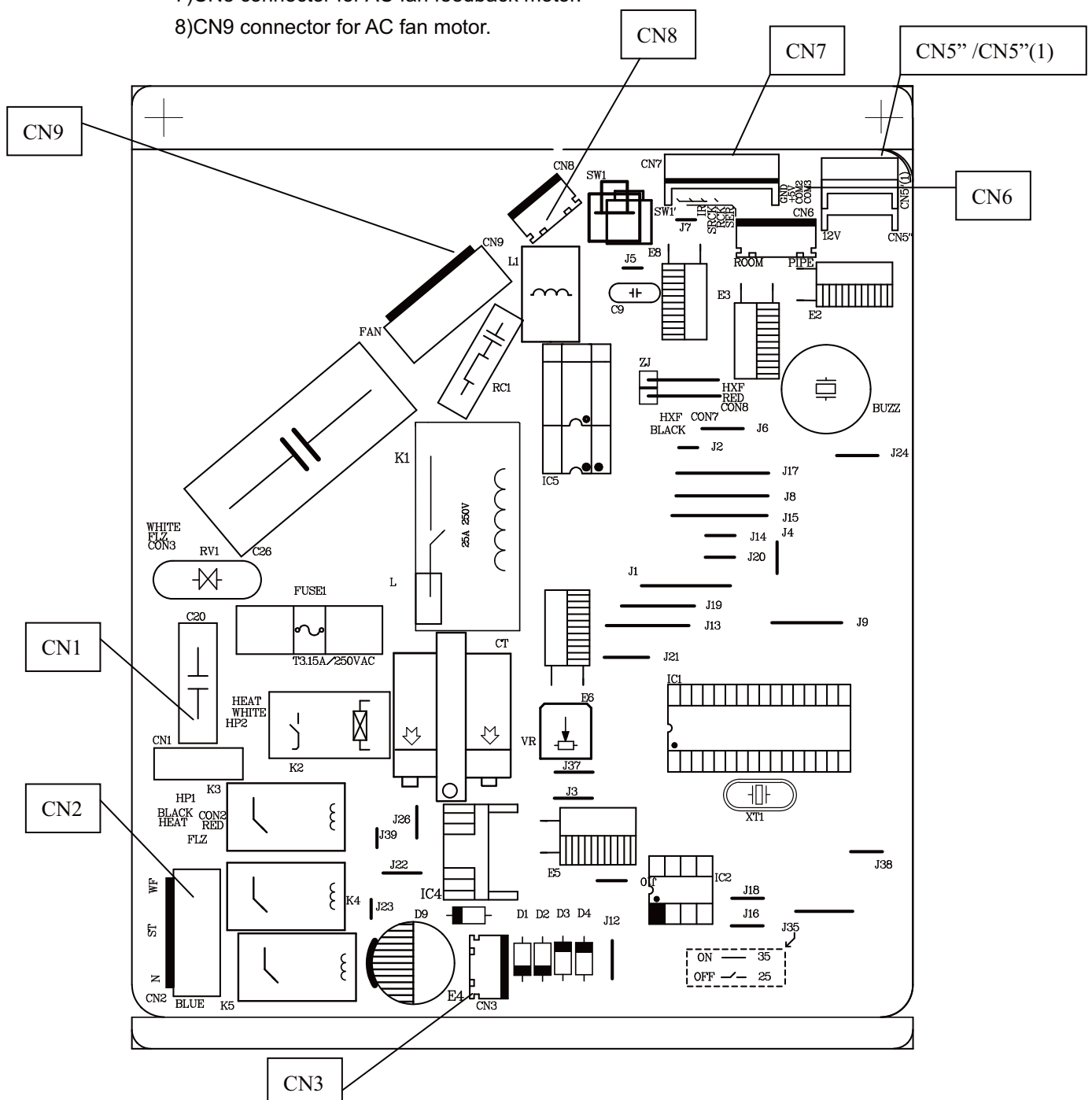

5. Functions and control

5.1 main functions and control specifications

Including brief introduction to air conditioners of series models and electric control function.

5.1.1 Automatic running

Automatic running mode

When the running mode is turned to automation after starting the system, the system will first determine the running mode according to the current room temperature and then will run according to the determined mode. T_r in the following selection conditions means room temperature, T_s means setting temperature, T_p means temperature of indoor coil pipe

- a. $T_r \geq 23^\circ\text{C}$ running cooling mode
- b. $T_r < 23^\circ\text{C}$ running heating mode

After turning to the automation mode, the running mode can be switched between cooling mode, fan mode and heating mode according to the change of the indoor ambient temperature. But the automatic conversion between cooling mode and heating mode must be conducted after 15 minutes.

5.1.2 Indoor temperature control

Temperature control range : 16°C — 30°C

Temperature control precision: $\pm 1^\circ\text{C}$

Compressor can't be controlled by temperature sensor within 2 minutes after it starts

5.1.2.1 Cooling mode:

When $T_r > T_s$, outdoor fan motor and compressor on, and indoor fan motor run at fixed wind speed. When $T_r < T_s$, outdoor fan motor and compressor off, and when $T_r > T_s$, outdoor fan motor and compressor are working again. If $T_r = T_s$, the indoor fan motor, outdoor fan motor and the compressor's state will not change.

5.1.2.2 Heating mode:

When $T_r \leq T_s$, compressor, four-ways valve and outdoor fan motor is on, indoor fan motor runs as in cold blast avoidance mode, and 4°C of compensation is added after compressor is started.

When $T_r > T_s + 5^\circ\text{C}$, compressor is off, and the indoor fan motor runs as in cold blast avoidance mode.

When $T_r < T_s + 5^\circ\text{C}$, compressor, four-ways valve and outdoor fan motor is on, and the indoor fan motor runs as in the mode of avoiding cold blast.

5.1.3 Cooling run mode:

temperature control range : 16°C — 30°C

temperature control precision: $\pm 1^\circ\text{C}$

compressor can't be controlled by temperature sensor within 2 minutes after it starts.

control character: when $T_r \geq T_s$, outlet air from compressor is on and indoor fan motor run at fixed wind speed. When $T_r < T_s$, outlet air from compressor is off, and when $T_r > T_s$, outlet air from compressor is on.

wind speed control: (the temperature difference is 1°C)

auto: when $T_r \geq T_s + 3^\circ\text{C}$, the wind speed is high;

When $T_s + 1^\circ\text{C} \leq T_r < T_s + 3^\circ\text{C}$, the wind speed is medium.

When $T_r < T_s + 1^\circ\text{C}$, the wind speed is low.

When temperature sensor is off, the fan motor runs at low speed.

when the wind speed changes from low to high, there is no delay, and when it changes from high to low, there is a 3-minutes delay before conversion.

Manual operation: When unit is on the wind speed can be set to high, medium, low or automatic as required (execute instruction 2 seconds later after receiving remote signal)

Compressor control: The compressor can't be controlled by temperature sensor within 2 minutes after start up and can be only restarted at least 3 minutes later after shutdown. There is no 3-minute protection with power on for the first time (over 3 minutes with power off). The compressor must stand by for 3 minutes before it is restarted after shut down.

There is no 2-minute limit when changing the temperature setting or shutting down the machine through the remote controller, and the machine can be shut down immediately.

Avoiding electrical shock: outlet air is available 2 seconds later after startup.

High temperature expiration prevention:

When the temp. of coil pipe is above 62°C , compressor and outlet air stop running 10 seconds later, and inlet air runs as the temp. sensor is off. When compressor stands by for 3 minute and the temp. of coil pipe is below 60°C , the unit can be started again.

Protection of frost is available (disable in test run or heating mode): In order to prevent the indoor heat exchanger from freezing (in refrigeration or dehumidifying mode), the compressor will be shut off when the temperature of the indoor coil pipe is or below 0°C and the compressor runs for over 5 minutes. When the temperature of the indoor coil pipe ascends to over 7°C , the compressor is restarted (must meet a 3-minutes delay)

Timer on, Timer off and sleep control are available.

5.1.4 Dehumidifying mode :

Temperature control range : 16°C — 30°C

Control character:

When T_r (indoor temperature) $> T_s$ (temperature setting) $+2^{\circ}\text{C}$, compressor and outdoor fan motor run continuously with indoor fan motor running in accordance with the wind speed setting (State 1).

When $T_s \leq T_r \leq T_s + 2^{\circ}\text{C}$, outlet air from compressor is on for 10 minutes and off for 6 minutes, the indoor fan motor is off in 3 minutes after shut down of compressor and gives breeze in other time (State 2).

When $T_r < T_s$, outlet air from compressor is unavailable, and the indoor fan motor enter breeze mode 3 minutes later after after shut down of compressor (State 3).

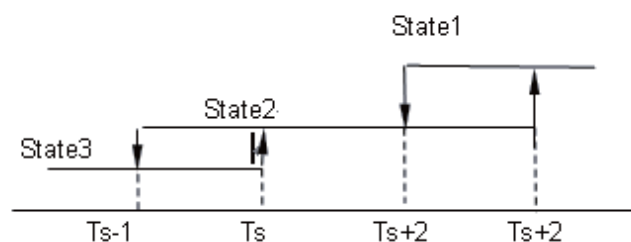

When all the ranges alternate, there is $\pm 1^{\circ}\text{C}$ difference.

5.1.5 Heating mode: (cooling only have no the mode)

*Temperature control range : 16°C — 30°C

*Temperature control precision: $\pm 1^{\circ}\text{C}$

*Control Character:

When $T_r \leq T_s$, compressor, four-ways valve and outdoor fan motor is on, indoor fan motor runs as in cold blast mode, and 4°C of compensation is added after compressor is started.

5.1.5.3.1 Entry conditions of defrosting:

The entry conditions of defrosting is classified into two types: intelligitized defrosting and sensor defrosting. Through selecting and judging, the models without outdoor sensor defrosts according to intelligitized defrosting, and others with ensor defrosts according to sensor defrosting.

Intelligitized defrosting:

5.1.5.3.1.1 Indoor unit enter overload protection and air outlet stops when air outlet has been restarted and runs over 10 minutes, and compressor runs over 45 minutes in total and over 20 minutes continuously, and the temp. of indoor coil pipe is below 38°C.

5.1.5.3.1.2 Compressor runs 20 minutes continuously, and the temp. of indoor coil pipe decreases 1°C per 6 minutes and this operation repeats 3 times, and the temp. of coil pipe is below 38°C, and 5 minutes later after compressor is restarted.

5.1.5.3.1.3 When compressor runs over 3 hours in total and over 20 minutes continuously and after the temp. of indoor coil pipe is below 38°C, the system enters defrosting mode.

5.1.5.3.1.4 The difference between the temp. of indoor coil pipe and the indoot temp. is below 16°C and lasts 5 minutes, compressor runs over 45 minutes in total and over 20 minutes continuously after the temp. of indoor coil pipe is below 38°C, the system enters defrosting mode.

5.1.5.3.2 Exit conditions of defrosting:

Defrosting time is higher than 12 minutes (compressor is on).

5.1.5.3.2.1 During the defrosting, if current peak value is cut off, the unit quit the defrosting mode. But the protection of expiration of current peak value is unavailable with 60 seconds after compressor is started.

5.1.5.3.2.2 During the defrosting and 2 minutes After quitting the defrosting mode, abnormality of temp. sensor isn't detected.

5.1.5.3.2.3 After quitting the defrosting mode, the fan motor enter cooling prevention mode

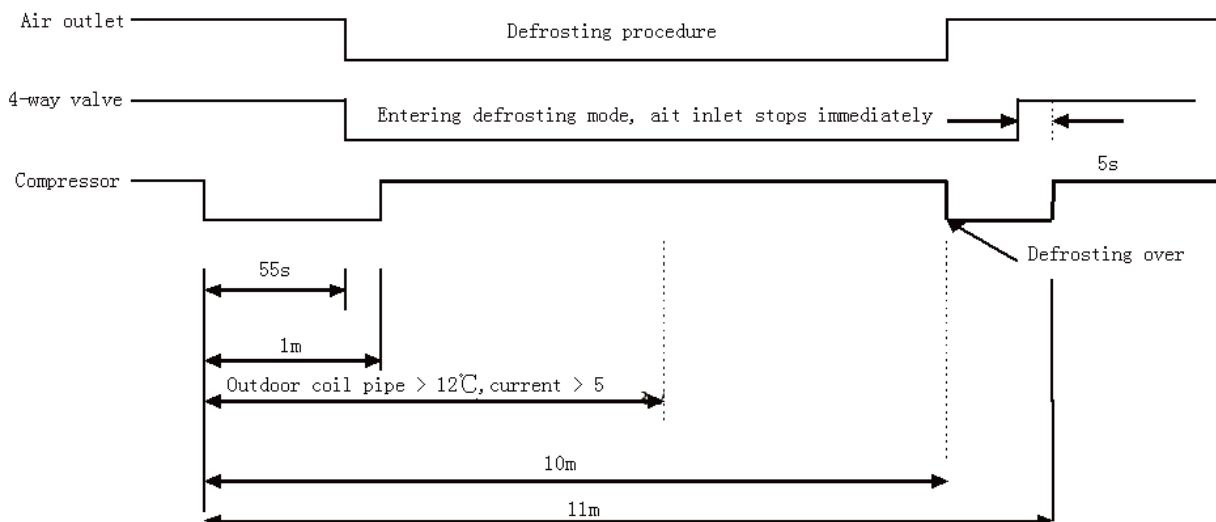

5.1.6 Timer function:

You can set 24-hour timer on or timer off as required, and the minum time unit is 1 minute. After setting, the indicator of indoor unit is on , and it is off when timer setting is completed. There are several timer mode as follows.

5.1.6.1 Timer on: The LED of "timer on" lights up, and unit behaves with halt status. Timer on is completed, and then unit starts running with the LED of "timer on" off. The unit starts with the the last setting receiving timer signals, and sleep setting is not allowed.

5.1.5.3.1 Entry conditions of defrosting:

The entry conditions of defrosting is classified into two types: intelligitized defrosting and sensor defrosting. Through selecting and judging, the models without outdoor sensor defrosts according to intelligitized defrosting, and others with ensor defrosts according to sensor defrosting.

Intelligitized defrosting:

5.1.5.3.1.1 Indoor unit enter overload protection and air outlet stops when air outlet has been restarted and runs over 10 minutes, and compressor runs over 45 minutes in total and over 20 minutes continuously, and the temp. of indoor coil pipe is below 38°C.

5.1.5.3.1.2 Compressor runs 20 minutes continuously, and the temp. of indoor coil pipe decreases 1°C per 6 minutes and this operation repeats 3 times, and the temp. of coil pipe is below 38°C, and 5 minutes later after compressor is restarted.

5.1.5.3.1.3 When compressor runs over 3 hours in total and over 20 minutes continuously and after the temp. of indoor coil pipe is below 38°C, the system enters defrosting mode.

5.1.5.3.1.4 The difference between the temp. of indoor coil pipe and the indoor temp. is below 16°C and lasts 5 minutes, compressor runs over 45 minutes in total and over 20 minutes continuously after the temp. of indoor coil pipe is below 38°C, the system enters defrosting mode.

5.1.5.3.2 Exit conditions of defrosting:

Defrosting time is higher than 12 minutes (compressor is on).

5.1.5.3.2.1 During the defrosting, if current peak value is cut off, the unit quit the defrosting mode. But the protection of expiration of current peak value is unavailable with 60 seconds after compressor is started.

5.1.5.3.2.2 During the defrosting and 2 minutes After quitting the defrosting mode, abnormality of temp. sensor isn't detected.

5.1.5.3.2.3 After quitting the defrosting mode, the fan motor enter cooling prevention mode.

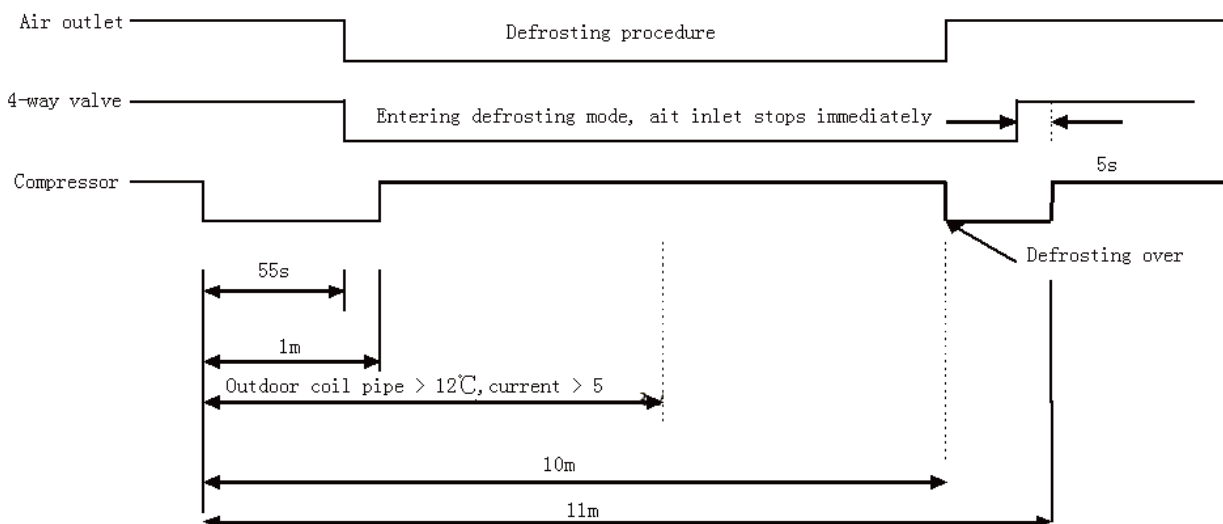

5.1.6 Timer function:

You can set 24-hour timer on or timer off as required, and the minum time unit is 1 minute. After setting, the indicator of indoor unit is on, and it is off when timer setting is completed. There are several timer mode as follows.

5.1.6.1 Timer on: The LED of "timer on" lights up, and unit behaves with halt status. Timer on is completed, and then unit starts running with the LED of "timer on" off. The unit starts with the the last setting receiving timer signals, and sleep setting is not allowed.

5.1.6.2 Timer off: Unit starts, timer indicator lights up; When reaching time setting, the indicator goes out, unit enters shut down mode, and sleep function can be set. If timer off and sleep are set synchronously, the one which time is short run first. Executing shutdown instruction clear timer and sleep function.

5.1.6.3 Timer on and timer off can be set synchronously.

5.1.7 Sleep function: the timer indicator lights up.

5.1.7.1 In cooling/defrosting mode, the temp. setting increases 1°C one hour later after start up. After another hour the temp. setting increase by more 1°C and then run continuously for another 6 hours and then close.

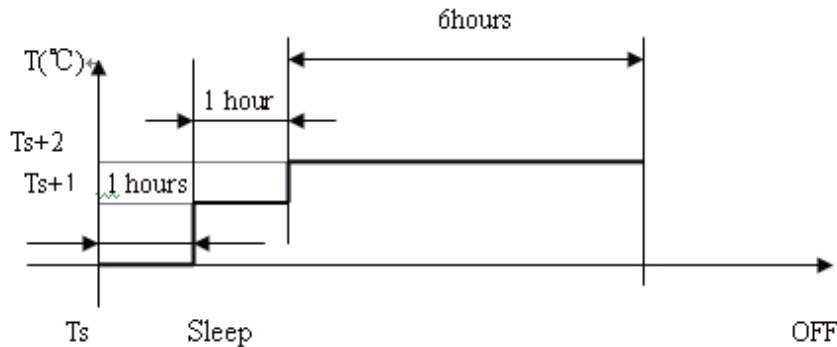

5.1.7.2 In heating mode, the temp. setting decrease 2°C one hour after start up. After another hour the temp. setting decrease by more 2°C . After 3 hours the temp. setting rise by 1°C and then run continuously for another 3 hours and then close.

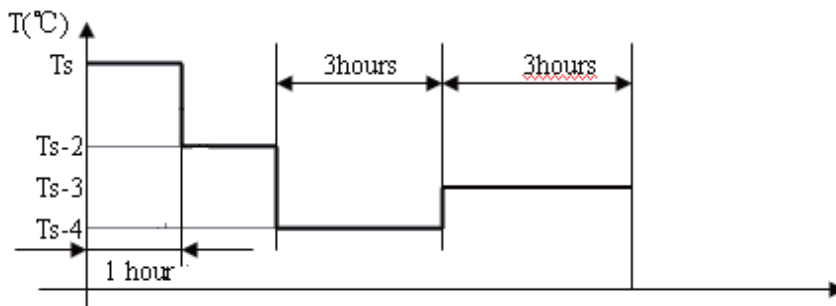

5.1.7.3 If the wind speed is set to high before going to bed, the wind speed become medium after start up; If the wind speed is set to medium before going to bed, the wind speed become low after start up; If the wind speed is set to low before going to bed, the wind speed keep unchanged.

5.1.8 Emergency switch input:

5.1.8.1 Press the switch of emergency operation, then buzzer rings once and unit enters the automatic operation mode. (emergency operation)

5.1.8.2 If the switch is kept pressed for 5 seconds, buzzer ring two times and unit enter enter test run mode.

5.1.8.3 Press the switch again, and then closes.

5.1.8.4 Enter emergency operation from timer mode, then timer is cancelled.

5.1.9 Test run:

5.1.9.1 The temperature sensor of inlet air doesn't work, and compressor starts (but subject to the limit of -minute delay excluding the first time), and high wind, cooling, and air door is open. The indoor fan motor runs, running indicator lights up, compressor relay and the one of outdoor fan motor is closed

5.1.9.2 During test run:

The prevention of freezing of evaporator doesn't work.

Current cross control doesn't work.

The control of current cross peak expiration doesn't work.

Temperature control doesn't work.

Temperature expiration control doesn't work.

5.1.10 memory function: The memory function of power down is available, and the auto recovery function of power on is optional. (In auto, heating, cooling, or defrosting status, press the "sleeping" button 10 times within 5 seconds, and the auto recovery function of power on can be set on/off. If the buzzer rings 4 times, the the auto recovery function of power on is available; If the buzzer rings 2 times, the the auto recovery function of power on is unavailable.)

If there is no EEPROM, the unit is taken off the 'off' function of the memory function of power down. But the memory function of power down can also be set on/off, and the data is the default value of chip.

5.1.11 Alarm from indoor fan motor: 2 minutes later after the indoor fan motor is charged, and the impulse from fan motor is not detected, hen send alarm signals.

5.2 Value of Thermistor

5.2.1 Indoor unit

Room sensor

R25°C=23KΩ±3.5%

B25°C/50°C=4200K±3%

Temp.(°C)	Max.(KΩ)	Normal(KΩ)	Min.(KΩ)	Tolerance(°C)	
				-1.97	1.75
-30	568.8372	501.0746	440.8435	-1.97	1.75
-29	530.9600	468.6491	413.1441	-1.95	1.74
-28	495.8488	438.5314	387.3645	-1.93	1.72
-27	463.2850	410.5433	363.3602	-1.91	1.71
-26	433.0683	384.5212	340.9980	-1.90	1.70
-25	405.0156	360.3153	320.1558	-1.88	1.69
-24	378.9588	337.7879	300.7211	-1.86	1.67
-23	354.7440	316.8126	282.5905	-1.84	1.66
-22	332.2300	297.2732	265.6686	-1.82	1.64
-21	311.2873	279.0627	249.8676	-1.80	1.63
-20	291.7969	262.0831	235.1067	-1.78	1.62
-19	273.6494	246.2437	221.3111	-1.76	1.60
-18	256.7445	231.4612	208.4122	-1.74	1.59
-17	240.9897	217.6590	196.3462	-1.72	1.57
-16	226.3000	204.7662	185.0545	-1.70	1.56
-15	212.5973	192.7176	174.4829	-1.68	1.54
-14	199.8093	181.4531	164.5813	-1.66	1.53
-13	187.8698	170.9169	155.3033	-1.64	1.51
-12	176.7176	161.0578	146.6059	-1.62	1.49
-11	166.2961	151.8284	138.4495	-1.60	1.48
-10	156.5532	143.1847	130.7973	-1.58	1.46
-9	147.4409	135.0863	123.6153	-1.56	1.44
-8	138.9148	127.4956	116.8717	-1.53	1.43

-7	130.9337	120.3778	110.5374	-1.51	1.41
-6	123.4597	113.7009	104.5852	-1.49	1.39
-5	116.4577	107.4349	98.9897	-1.47	1.38
-4	109.8953	101.5523	93.7278	-1.45	1.36
-3	103.7422	96.0274	88.7774	-1.43	1.34
-2	97.9708	90.8365	84.1185	-1.40	1.32
-1	92.5551	85.9574	79.7322	-1.38	1.30
0	87.4712	81.3697	75.6011	-1.36	1.29
1	82.6970	77.0544	71.7088	-1.34	1.27
2	78.2118	72.9937	68.0402	-1.31	1.25
3	73.9966	69.1712	64.5813	-1.29	1.23
4	70.0335	65.5716	61.3188	-1.27	1.21
5	66.3062	62.1807	58.2405	-1.24	1.19
6	62.7992	58.9853	55.3351	-1.22	1.17
7	59.4984	55.9729	52.5917	-1.20	1.15
8	56.3905	53.1320	50.0006	-1.17	1.13
9	53.4631	50.4521	47.5523	-1.15	1.11
10	50.7048	47.9230	45.2384	-1.13	1.09
11	48.1049	45.5355	43.0505	-1.10	1.07
12	45.6534	43.2808	40.9813	-1.08	1.04
13	43.3410	41.1509	39.0236	-1.05	1.02
14	41.1592	39.1381	37.1708	-1.03	1.00
15	39.0998	37.2355	35.4167	-1.00	0.98
16	37.1553	35.4363	33.7555	-0.98	0.96
17	35.3186	33.7344	32.1818	-0.95	0.94
18	33.5833	32.1240	30.6905	-0.93	0.91
19	31.9432	30.5997	29.2769	-0.90	0.89
20	30.3925	29.1565	27.9365	-0.88	0.87
21	28.9259	27.7895	26.6651	-0.85	0.84
22	27.5383	26.4944	25.4589	-0.83	0.82
23	26.2252	25.2670	24.3140	-0.80	0.80
24	24.9822	24.1034	23.2271	-0.78	0.77
25	23.8050	23.0000	22.1950	-0.78	0.77
26	22.7500	21.9499	21.1520	-0.78	0.78
27	21.7477	20.9536	20.1638	-0.82	0.81
28	20.7951	20.0081	19.2272	-0.86	0.85
29	19.8895	19.1104	18.3394	-0.89	0.88
30	19.0285	18.2581	17.4974	-0.93	0.92
31	18.2094	17.4484	16.6988	-0.97	0.95
32	17.4302	16.6792	15.9410	-1.00	0.99
33	16.6885	15.9480	15.2217	-1.04	1.02
34	15.9825	15.2530	14.5389	-1.08	1.06
35	15.3103	14.5920	13.8903	-1.12	1.09
36	14.6700	13.9632	13.2743	-1.16	1.13
37	14.0599	13.3650	12.6889	-1.20	1.16

38	13.4786	12.7957	12.1325	-1.23	1.20
39	12.9244	12.2537	11.6035	-1.27	1.24
40	12.3960	11.7375	11.1004	-1.31	1.27
41	11.8921	11.2459	10.6218	-1.35	1.31
42	11.4113	10.7775	10.1665	-1.39	1.34
43	10.9526	10.3311	9.7330	-1.43	1.38
44	10.5147	9.9056	9.3204	-1.48	1.42
45	10.0967	9.4999	8.9275	-1.52	1.45
46	9.6976	9.1130	8.5532	-1.56	1.49
47	9.3163	8.7439	8.1965	-1.60	1.53
48	8.9521	8.3916	7.8566	-1.64	1.57
49	8.6040	8.0554	7.5327	-1.68	1.60
50	8.2713	7.7345	7.2237	-1.73	1.64
51	7.9531	7.4280	6.9291	-1.77	1.68
52	7.6489	7.1353	6.6480	-1.81	1.72
53	7.3580	6.8556	6.3797	-1.85	1.76
54	7.0796	6.5884	6.1237	-1.90	1.79
55	6.8131	6.3329	5.8793	-1.94	1.83
56	6.5581	6.0887	5.6459	-1.99	1.87
57	6.3140	5.8552	5.4230	-2.03	1.91
58	6.0802	5.6318	5.2100	-2.07	1.95
59	5.8563	5.4181	5.0065	-2.12	1.99
60	5.6417	5.2136	4.8120	-2.16	2.03
61	5.4361	5.0178	4.6260	-2.21	2.07
62	5.2391	4.8304	4.4481	-2.25	2.11
63	5.0502	4.6510	4.2780	-2.30	2.15
64	4.8691	4.4791	4.1153	-2.35	2.19
65	4.6954	4.3145	3.9596	-2.39	2.23
66	4.5287	4.1567	3.8105	-2.44	2.27
67	4.3689	4.0055	3.6678	-2.49	2.31
68	4.2154	3.8605	3.5312	-2.53	2.35
69	4.0682	3.7216	3.4004	-2.58	2.39
70	3.9268	3.5883	3.2750	-2.63	2.43
71	3.7910	3.4605	3.1549	-2.68	2.48
72	3.6606	3.3378	3.0398	-2.73	2.52
73	3.5353	3.2201	2.9294	-2.77	2.56
74	3.4150	3.1072	2.8237	-2.82	2.60
75	3.2993	2.9987	2.7222	-2.87	2.64
76	3.1881	2.8946	2.6249	-2.92	2.68
77	3.0812	2.7946	2.5316	-2.97	2.73
78	2.9785	2.6986	2.4420	-3.02	2.77
79	2.8796	2.6063	2.3560	-3.07	2.81
80	2.7845	2.5176	2.2735	-3.12	2.86
81	2.6931	2.4324	2.1943	-3.17	2.90
82	2.6050	2.3505	2.1182	-3.22	2.94

83	2.5203	2.2717	2.0451	-3.28	2.99
84	2.4388	2.1960	1.9749	-3.33	3.03
85	2.3602	2.1231	1.9075	-3.38	3.07
86	2.2846	2.0530	1.8426	-3.43	3.12
87	2.2118	1.9856	1.7803	-3.48	3.16
88	2.1416	1.9207	1.7204	-3.54	3.20
89	2.0740	1.8582	1.6628	-3.59	3.25
90	2.0089	1.7981	1.6074	-3.64	3.29
91	1.9461	1.7402	1.5541	-3.70	3.34
92	1.8856	1.6844	1.5028	-3.75	3.38
93	1.8272	1.6307	1.4535	-3.80	3.43
94	1.7709	1.5789	1.4060	-3.86	3.47
95	1.7166	1.5291	1.3603	-3.91	3.52
96	1.6643	1.4810	1.3163	-3.97	3.56
97	1.6138	1.4347	1.2739	-4.02	3.61
98	1.5650	1.3900	1.2331	-4.08	3.66
99	1.5180	1.3470	1.1937	-4.13	3.70
100	1.4726	1.3054	1.1559	-4.19	3.75
101	1.4287	1.2654	1.1194	-4.24	3.80
102	1.3864	1.2268	1.0842	-4.30	3.84
103	1.3455	1.1895	1.0503	-4.36	3.89
104	1.3060	1.1535	1.0176	-4.42	3.94
105	1.2679	1.1188	0.9860	-4.47	3.98
106	1.2310	1.0853	0.9556	-4.53	4.03
107	1.1954	1.0529	0.9263	-4.59	4.08
108	1.1610	1.0217	0.8980	-4.65	4.13
109	1.1277	0.9915	0.8707	-4.70	4.17
110	1.0955	0.9624	0.8443	-4.76	4.22
111	1.0644	0.9342	0.8189	-4.82	4.27
112	1.0344	0.9070	0.7943	-4.88	4.32
113	1.0053	0.8807	0.7706	-4.94	4.37
114	0.9771	0.8553	0.7478	-5.00	4.41
115	0.9499	0.8307	0.7256	-5.06	4.46
116	0.9235	0.8070	0.7043	-5.12	4.51
117	0.8980	0.7840	0.6837	-5.18	4.56
118	0.8734	0.7618	0.6637	-5.24	4.61
119	0.8495	0.7404	0.6445	-5.30	4.66
120	0.8263	0.7196	0.6258	-5.36	4.71

Pipe Sensor

R25°C=10KΩ±3%

B25°C/50°C=3700K±3%

Temp.(°C)	Max.(KΩ)	Normal(KΩ)	Min.(KΩ)	Tolerance(°C)	
-30	165.2170	147.9497	132.3678	-1.94	1.75
-29	155.5754	139.5600	125.0806	-1.93	1.74

-28	146.5609	131.7022	118.2434	-1.91	1.73
-27	138.1285	124.3392	111.8256	-1.89	1.71
-26	130.2371	117.4366	105.7989	-1.87	1.70
-25	122.8484	110.9627	100.1367	-1.85	1.69
-24	115.9272	104.8882	94.8149	-1.83	1.67
-23	109.4410	99.1858	89.8106	-1.81	1.66
-22	103.3598	93.8305	85.1031	-1.80	1.64
-21	97.6556	88.7989	80.6728	-1.78	1.63
-20	92.3028	84.0695	76.5017	-1.76	1.62
-19	87.2775	79.6222	72.5729	-1.74	1.60
-18	82.5577	75.4384	68.8710	-1.72	1.59
-17	78.1230	71.5010	65.3815	-1.70	1.57
-16	73.9543	67.7939	62.0907	-1.68	1.55
-15	70.0342	64.3023	58.9863	-1.66	1.54
-14	66.3463	61.0123	56.0565	-1.64	1.52
-13	62.8755	57.9110	53.2905	-1.62	1.51
-12	59.6076	54.9866	50.6781	-1.60	1.49
-11	56.5296	52.2278	48.2099	-1.58	1.47
-10	53.6294	49.6244	45.8771	-1.56	1.46
-9	50.8956	47.1666	43.6714	-1.54	1.44
-8	48.3178	44.8454	41.5851	-1.51	1.42
-7	45.8860	42.6525	39.6112	-1.49	1.40
-6	43.5912	40.5800	37.7429	-1.47	1.39
-5	41.4249	38.6207	35.9739	-1.45	1.37
-4	39.3792	36.7676	34.2983	-1.43	1.35
-3	37.4465	35.0144	32.7108	-1.41	1.33
-2	35.6202	33.3552	31.2062	-1.38	1.31
-1	33.8936	31.7844	29.7796	-1.36	1.29
0	32.2608	30.2968	28.4267	-1.34	1.28
1	30.7162	28.8875	27.1431	-1.32	1.26
2	29.2545	27.5519	25.9250	-1.29	1.24
3	27.8708	26.2858	24.7686	-1.27	1.22
4	26.5605	25.0851	23.6704	-1.25	1.20
5	25.3193	23.9462	22.6273	-1.23	1.18
6	24.1432	22.8656	21.6361	-1.20	1.16
7	23.0284	21.8398	20.6939	-1.18	1.14
8	21.9714	20.8659	19.7982	-1.15	1.12
9	20.9688	19.9409	18.9463	-1.13	1.09
10	20.0176	19.0621	18.1358	-1.11	1.07
11	19.1149	18.2270	17.3646	-1.08	1.05
12	18.2580	17.4331	16.6305	-1.06	1.03
13	17.4442	16.6782	15.9315	-1.03	1.01
14	16.6711	15.9601	15.2657	-1.01	0.99
15	15.9366	15.2770	14.6315	-0.98	0.96
16	15.2385	14.6268	14.0271	-0.96	0.94

17	14.5748	14.0079	13.4510	-0.93	0.92
18	13.9436	13.4185	12.9017	-0.91	0.90
19	13.3431	12.8572	12.3778	-0.88	0.87
20	12.7718	12.3223	11.8780	-0.86	0.85
21	12.2280	11.8126	11.4011	-0.83	0.83
22	11.7102	11.3267	10.9459	-0.81	0.80
23	11.2172	10.8634	10.5114	-0.78	0.78
24	10.7475	10.4216	10.0964	-0.75	0.75
25	10.3000	10.0000	9.7000	-0.75	0.75
26	9.8975	9.5974	9.2980	-0.76	0.76
27	9.5129	9.2132	8.9148	-0.80	0.80
28	9.1454	8.8465	8.5496	-0.84	0.83
29	8.7942	8.4964	8.2013	-0.87	0.86
30	8.4583	8.1621	7.8691	-0.91	0.90
31	8.1371	7.8428	7.5522	-0.95	0.93
32	7.8299	7.5377	7.2498	-0.98	0.97
33	7.5359	7.2461	6.9611	-1.02	1.00
34	7.2546	6.9673	6.6854	-1.06	1.04
35	6.9852	6.7008	6.4222	-1.10	1.07
36	6.7273	6.4459	6.1707	-1.13	1.11
37	6.4803	6.2021	5.9304	-1.17	1.14
38	6.2437	5.9687	5.7007	-1.21	1.18
39	6.0170	5.7454	5.4812	-1.25	1.22
40	5.7997	5.5316	5.2712	-1.29	1.25
41	5.5914	5.3269	5.0704	-1.33	1.29
42	5.3916	5.1308	4.8783	-1.37	1.33
43	5.2001	4.9430	4.6944	-1.41	1.36
44	5.0163	4.7630	4.5185	-1.45	1.40
45	4.8400	4.5905	4.3500	-1.49	1.44
46	4.6708	4.4252	4.1887	-1.53	1.47
47	4.5083	4.2666	4.0342	-1.57	1.51
48	4.3524	4.1145	3.8862	-1.61	1.55
49	4.2026	3.9686	3.7443	-1.65	1.59
50	4.0588	3.8287	3.6084	-1.70	1.62
51	3.9206	3.6943	3.4780	-1.74	1.66
52	3.7878	3.5654	3.3531	-1.78	1.70
53	3.6601	3.4416	3.2332	-1.82	1.74
54	3.5374	3.3227	3.1183	-1.87	1.78
55	3.4195	3.2085	3.0079	-1.91	1.82
56	3.3060	3.0989	2.9021	-1.95	1.85
57	3.1969	2.9935	2.8005	-2.00	1.89
58	3.0919	2.8922	2.7029	-2.04	1.93
59	2.9909	2.7948	2.6092	-2.08	1.97
60	2.8936	2.7012	2.5193	-2.13	2.01
61	2.8000	2.6112	2.4328	-2.17	2.05

62	2.7099	2.5246	2.3498	-2.22	2.09
63	2.6232	2.4413	2.2700	-2.26	2.13
64	2.5396	2.3611	2.1932	-2.31	2.17
65	2.4591	2.2840	2.1195	-2.36	2.21
66	2.3815	2.2098	2.0486	-2.40	2.25
67	2.3068	2.1383	1.9803	-2.45	2.29
68	2.2347	2.0695	1.9147	-2.49	2.34
69	2.1652	2.0032	1.8516	-2.54	2.38
70	2.0983	1.9393	1.7908	-2.59	2.42
71	2.0337	1.8778	1.7324	-2.63	2.46
72	1.9714	1.8186	1.6761	-2.68	2.50
73	1.9113	1.7614	1.6219	-2.73	2.54
74	1.8533	1.7064	1.5697	-2.78	2.58
75	1.7974	1.6533	1.5194	-2.83	2.63
76	1.7434	1.6021	1.4710	-2.88	2.67
77	1.6913	1.5528	1.4243	-2.92	2.71
78	1.6409	1.5051	1.3794	-2.97	2.75
79	1.5923	1.4592	1.3360	-3.02	2.80
80	1.5454	1.4149	1.2942	-3.07	2.84
81	1.5000	1.3721	1.2540	-3.12	2.88
82	1.4562	1.3308	1.2151	-3.17	2.93
83	1.4139	1.2910	1.1776	-3.22	2.97
84	1.3730	1.2525	1.1415	-3.27	3.01
85	1.3335	1.2153	1.1066	-3.32	3.06
86	1.2953	1.1794	1.0730	-3.38	3.10
87	1.2583	1.1448	1.0405	-3.43	3.15
88	1.2226	1.1113	1.0092	-3.48	3.19
89	1.1880	1.0789	0.9789	-3.53	3.24
90	1.1546	1.0476	0.9497	-3.58	3.28
91	1.1223	1.0174	0.9215	-3.64	3.33
92	1.0910	0.9882	0.8942	-3.69	3.37
93	1.0607	0.9599	0.8679	-3.74	3.42
94	1.0314	0.9326	0.8424	-3.80	3.46
95	1.0030	0.9061	0.8179	-3.85	3.51
96	0.9756	0.8806	0.7941	-3.90	3.55
97	0.9490	0.8558	0.7711	-3.96	3.60
98	0.9232	0.8319	0.7489	-4.01	3.64
99	0.8983	0.8088	0.7275	-4.07	3.69
100	0.8741	0.7863	0.7067	-4.12	3.74
101	0.8507	0.7646	0.6867	-4.18	3.78
102	0.8281	0.7436	0.6672	-4.23	3.83
103	0.8061	0.7233	0.6484	-4.29	3.88
104	0.7848	0.7036	0.6303	-4.34	3.92
105	0.7641	0.6845	0.6127	-4.40	3.97
106	0.7441	0.6661	0.5957	-4.46	4.02

107	0.7247	0.6482	0.5792	-4.51	4.07
108	0.7059	0.6308	0.5632	-4.57	4.12
109	0.6877	0.6140	0.5478	-4.63	4.16
110	0.6700	0.5977	0.5328	-4.69	4.21
111	0.6528	0.5820	0.5183	-4.74	4.26
112	0.6361	0.5667	0.5043	-4.80	4.31
113	0.6200	0.5518	0.4907	-4.86	4.36
114	0.6043	0.5374	0.4775	-4.92	4.41
115	0.5891	0.5235	0.4648	-4.98	4.45
116	0.5743	0.5100	0.4524	-5.04	4.50
117	0.5600	0.4968	0.4404	-5.10	4.55
118	0.5460	0.4841	0.4288	-5.16	4.60
119	0.5325	0.4717	0.4175	-5.22	4.65
120	0.5194	0.4597	0.4066	-5.28	4.70

6. System Configuration

6.1 System Configuration

After the installation and test operation of the room air conditioner have been completed, it should be operated and handled as described below. Every user would like to know the correct method of operation of the room air conditioner, to check if it is capable of cooling (or heating) well, and to know a clever method of using it. In order to meet this expectation of the users, giving sufficient explanations taking enough time can be said to reduce about 80% of the requests for servicing. However good the installation work is and however good the functions are, the customer may blame either the room air conditioner or its installation work because of improper handling. The installation work and handing over of the unit can only be considered to have been completed when its handling has been explained to the user without using technical terms but giving full knowledge of the equipment.

6.2 Instruction

Parts and Functions

Indoor Unit

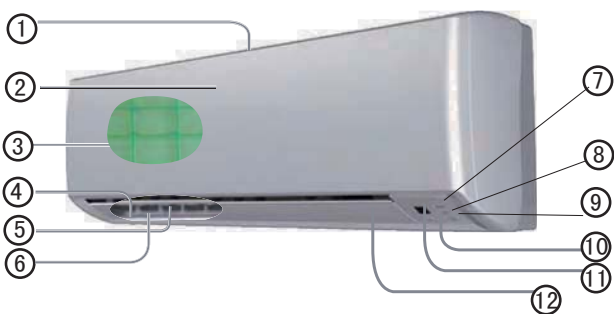

- ① Inlet
- ② Inlet grille
- ③ Air Purifying Filter (inside)
- ④ Outlet
- ⑤ Anion generator (inside)
- ⑥ Vertical blade
adjust left and right air flow
- ⑦ Power indicator (Lights up when unit starts.)
- ⑧ Timer mode indicator
(Lights up when Timer operation is selected.)
- ⑨ Operation mode indicator
(lights up when the compressor is on.)
- ⑩ Remote signal receiver
(A beeping sound is generated when a signal from remote controller is received.)
- ⑪ Ambient temp display
When receiving the remote control signal, display the set temperature and in the rest time the room temperature is displayed and this room temperature is only for reference.
- ⑫ Horizontal flap
adjust up and down air flow Don't adjust it manually

Actual inlet grille may vary from the one shown in the manual according to the product purchased

Outdoor Unit

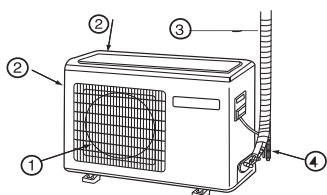

- ① OUTLET
- ② INLET
- ③ CONNECTING PIPING AND ELECTRICAL WIRING
- ④ DRAIN HOSE

Clock set

Press CLOCK button, "AM" or "PM" flashes. Press Δ or ∇ to set correct time. Each press will increase or decrease 1min. If the button is kept pressed, time will change quickly. After time setting is confirmed, press SET, "AM" and "PM" stop flashing, while clock starts working.

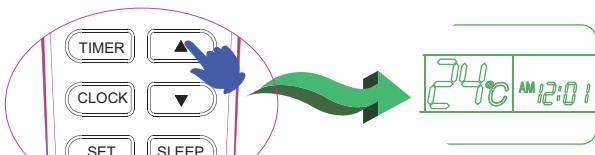

Remote controller

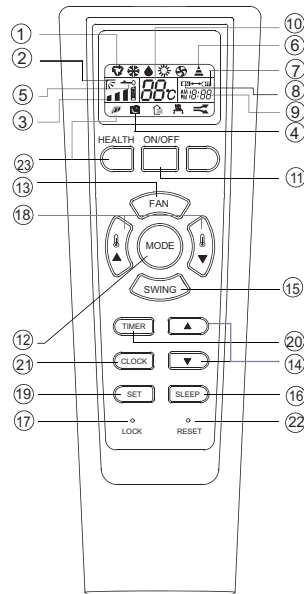

- 1. Mode display
- 2. SWING display
- 3. FAN SPEED display
- 4. SLEEP display
- 5. LOCK display
- 6. SIGNAL SENDING
- 7. TIMER OFF display
- 8. TIMER ON display
- 9. CLOCK display
- 10. TEMP display
- 11. POWER ON/OFF
Used for unit start and stop.
- 12. MODE
Used to select AUTO run, COOL, DRY, HEAT and FAN operation.
- 13. FAN
Used to select fan speed LO, MED, HI, AUTO
- 14. HOUR
Used to set clock and timer setting.
- 15. SWING
Used to set auto fan direction.
- 16. SLEEP
Used to select sleep mode.
- 17. LOCK
Used to lock buttons and LCD display.
- 18. TEMP.SETTING
Used to select your desired temp.
- 19. SET / LIGHT
Used to confirm timer and clock settings.
- 20. TIMER
Used to select TIMER ON, TIMER OFF, TIMER ON-OFF
- 21. CLOCK
Used to set correct time
- 22. RESET
Used to reset the controller back to normal condition.
- 23. HEALTH
Used to operate the healthy function and LCD display. (This function is unavailable on some models.)

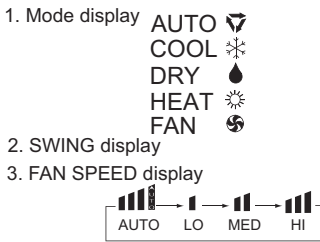

NOTE: Cooling only unit do not have displays and functions related with heating. If the unit which you purchased has healthy function, follow it. If not, please ignore.

Loading of the battery

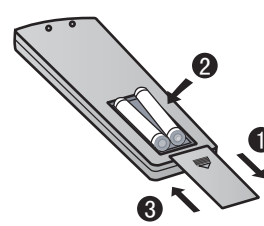

- 1 Remove the battery cover;
- 2 Load the batteries as illustrated. 2 R-03 batteries, resetting key (cylinder);
- 3 Be sure that the loading is in line with the "+" and "-";
- 4 Load the battery, then put on the cover again.

Note: The distance between the signal transmission head and the receiver hole should be within 7m without any obstacle as well. When electronic-started type fluorescent lamp or change-over wireless telephone is installed in the type fluorescent lamp or room, the receiver is apt to be disturbed in receiving the signals, so the distance to the indoor unit should be shorter. Full display or unclear display during operation indicates the batteries have been used up. Please change batteries. If the remote controller can't run normally during operation, please remove the batteries and reload several minutes later.

Hint: Remove the batteries in case unit won't be in usage for a long period. If there are any displays after taking-out, just need to press reset key.

Operation

Unit start / stop

Press ON/OFF button, unit starts or stops.

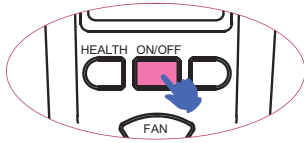

Select temp.setting

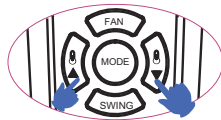

Operation Mode	Remote Controller	Note
AUTO		Under the mode of auto operation, air conditioner will automatically select Cool or Heat operation according to room temperature. When FAN is set to AUTO, the air conditioner automatically adjusts the fan speed according to room temperature.
COOL		
DRY		In DRY mode, when room temperature becomes lower than temp.setting+2°C, unit will run intermittently at LOW speed regardless of FAN setting.
HEAT		
FAN		In FAN operation mode, the unit will not operate in COOL or HEAT mode but only in FAN mode ,AUTO is not available in FAN mode.And temp.setting is disabled. In FAN mode,SLEEP operation is not available.

Cool Operation

Heat Operation

Note:
In HEAT mode,warm air will blow out after a short periodof the time due to cold-draft prevention function.
When FAN is set to AUTO, the air conditioner automatically adjusts the fan speed according to room temperature.

Auto Operation

According to the automatic choice system in temperature in indoors cold or make the hot movement

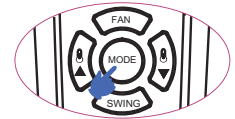

Dry Operation

Note:
In DRY mode, when room temperature becomes lower than temp. setting+2°C, unit will run intermittently at LOW speed regardless of FAN setting.

Fan Operation

- When FAN is set to AUTO, the air conditioner automatically adjusts the fan speed according to room temperature.
- In FAN operation mode the unit will not operate in COOL mode but only in FAN mode ,AUTO is not available in FAN mode.And temp.setting is disabled.

Air Flow Direction Adjustm

(1)

● Remote controller can memorize each operation status. When starting it next time,just press ON/OFF button and unit will run in previous status.

Operation

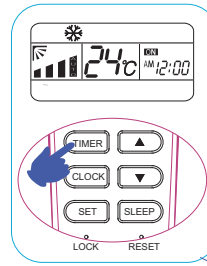

The anion generator in the air conditioner can generate a lot of anion effectively balance the quantity of positive and anion in the air and also to kill bacteria and speed up the dust sediment in the room and finally clean the air in the room.

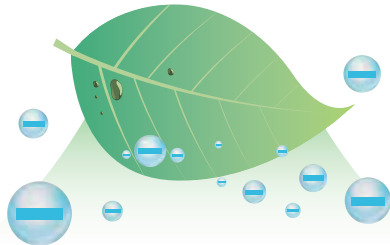

Healthy Negative ions

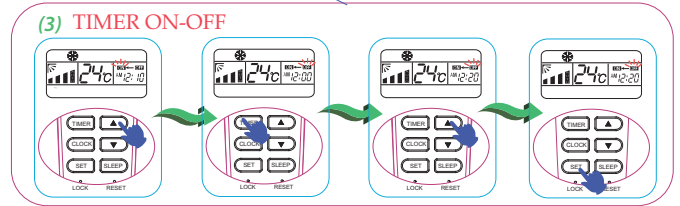

To cancel TIMER mode
 ● Just press TIMER button several times until TIMER mode disappears.

TIMER Operation

Set Clock correctly before starting Timer operation
 You can let unit start or stop automatically a following times:
 Before you wake up in the morning, or get back from outside
 or after you fall asleep at night.

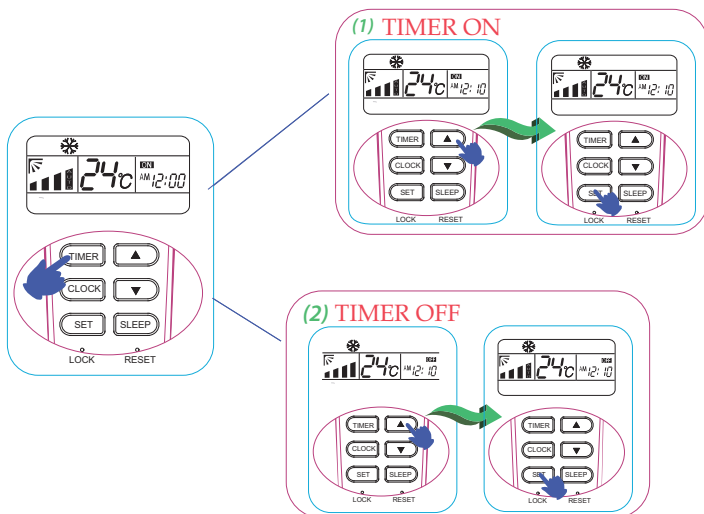

Emergency operation and test operation

Emergency Operation:

- Use this operation only when the remote controller is defective or lost.
- When the emergency operation switch is pressed, the "Pi" sound is heard once, which means the start of this operation.
- In this operation, the system automatically selects the operation modes, cooling or fan or heat, according to the room temperature.

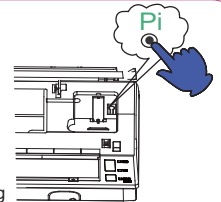

Room temperature	Operation mode	Designated temperature	Timer mode	Air flow
ABOVE 23°C	COOLING	26°C	NO	AUTOMATIC
BELOW 23°C	HEAT	23°C	NO	AUTOMATIC

(Cooling only unit) Room temperature	Operation mode	Designated temperature	Timer mode	Air flow
BELOW 23°C	FAN	26°C	NO	AUTOMATIC

- It is not possible to operate in dry mode.

Test operation:

- Test operation switch is the same as emergency switch.
- Use this switch in the test operation when the room temperature is below 16°C, do not use it in the normal operation.
- Continue to press the test operation switch for more than 5 seconds. After you hear the "Pi" sound twice, release your finger from the switch: the cooling operation starts with the air flow speed "Hi".

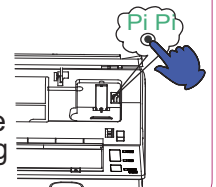

Operation

Comfortable SLEEP

Before going to bed, you can simply press the SLEEP button and unit will operate in SLEEP mode and bring you a sound sleep.

SLEEP Operation



2. In HEAT mode

1 hours after SLEEP mode starts, temp will become 2°C lower than temp. setting. After another 1 hours, temp decrease by 2°C further. After more another 3 hours, temp. rises by 1°C further. The unit will run for further 3 hours then stops. Temp. is lower than temp. setting so that room temperature won't be too high for your sleep.

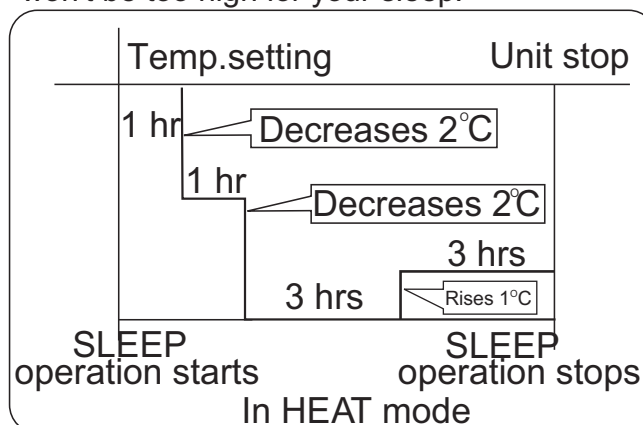

Operation Mode

1. In COOL, DRY mode

1 hours after SLEEP mode starts, temp. will become 1°C higher than temp. setting. After another 1 hours, temp. rises by 1°C further. The unit will run for further 6 hours then stops. Temp. is higher than temp. setting so that room temperature won't be too low for your sleep.

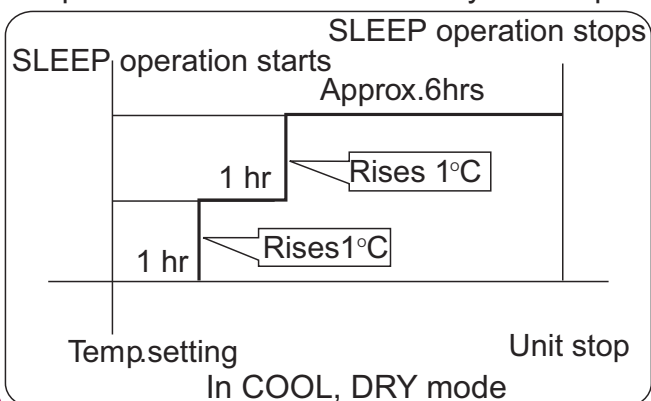

3. In AUTO mode

The unit operates in corresponding sleep mode corresponding sleep mode adapted to the automatically selected operation mode.

4. In FAN mode

It has no SLEEP function.

5. When quiet sleeping function is set to 8 hours the quiet sleeping time can not be adjusted. When TIMER function is set, the quiet sleeping function can't be set up. After the sleeping function is set up, if user resets TIMER function, the sleeping function will be cancelled; the machine will be in the state of timing-on, if the two modes are set up at the same time, either of their operation time is ended first, the unit will stop automatically, and the other mode will be cancelled.

Power Failure Resume Function

If the unit is started for the first time, the compressor will not start running unless 3 minutes have elapsed. When the power resumes after power failure, the unit will run automatically, and 3 minutes later the compressor starts running.

Note to the power failure resume:

press the sleep button ten times in five seconds and enter function after hearing four sounds. And press the sleep button ten times within five seconds and leave this function after hearing two sounds.

Maintenance

For Smart Use of The Air Conditioner

Setting of proper room temperature

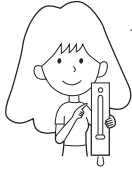

Proper temperature

Do not block the air inlet or outlet

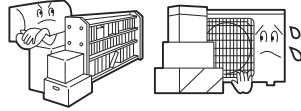

Close doors and windows during operation

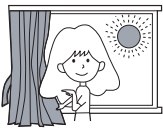

During cooling operation prevent the penetration of direct sunlight with curtain or blind

Use the timer effectively

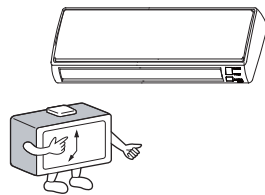

If the unit is not to be used for a long time, turn off the power supply main switch.



OFF

Use the louvers effectively



Remote Controller



Do not use water, wipe the controller with a dry cloth. Do not use glass cleaner or chemical cloth.

Indoor Body

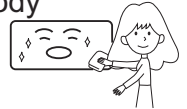

Wipe the air conditioner by using a soft and dry cloth. For serious stains, use a neutral detergent diluted with water. Wring the water out of the cloth before wiping, then wipe off the detergent completely.

Do not use the following for cleaning



Gasoline, benzene, thinner or cleanser may damage the coating of the unit.



Hot water over 40°C (104°F) may cause discoloring or deformation.

Air Filter cleaning

1 Open the inlet grille by pulling it upward.

2 Remove the filter.

Push up the filter's center tab slightly until it is released from the stopper, and remove the filter downward.

3 Clean the filter.

Use a vacuum cleaner to remove dust, or wash the filter with water. After washing, dry the filter completely in the shade.

4 Attach the filter.

Attach the filter correctly so that the "FRONT" indication is facing to the front. Make sure that the filter is completely fixed behind the stopper. If the right and left filters are not attached correctly, that may cause defects.

5 Close the inlet grille.

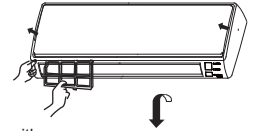

Once every two weeks

Replacement of Air Purifying Filter

(NOTE: Air purifying filter is optional part)

1. Open the Inlet Grille

Prop up the inlet grille by using a small device named grille-support which located in the right side of the indoor unit.



2. Detach the standard air filter

Slide the knob slightly upward to release the filter, then withdraw it.

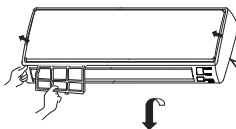

Detach old Air Purifying Filter



3. Attach Air Purifying Filter

Put air purifying filter appliances into the right and left filter frames.

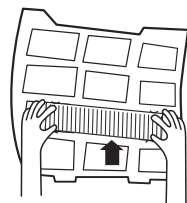

4. Attach the standard air filter

(Necessary installation)

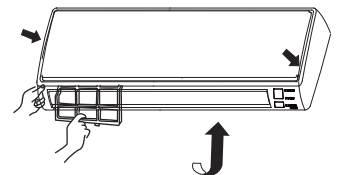

ATTENTION:

The white side of the photocatalyst air purifying filter face outside, and the black side face the unit.

The green side of the bacteria-killing medium air purifying filter face outside, and the white side face the unit.

5. Close the Inlet Grille

Close the Grille surely

NOTE:













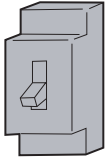

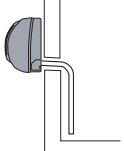





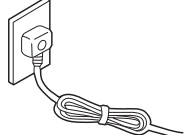

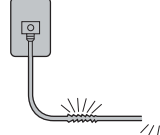
- The photocatalyst air purifying filter will be solarized in fixed time. In normal family, it will be solarized every 6 months.
- The bacteria-killing medium air purifying filter will be used for a long time, no need for replacement. But in the period of using them, you should remove the dust frequently by using vacuum cleaner or flapping them lightly, otherwise, its performance will be affected.
- Please keep the bacteria-killing medium air purifying filter in the cool and dry conditions avoid long time directly sunshine when you stop using it, or its ability of sterilization will be reduced.

Cautions





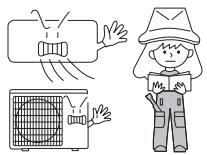





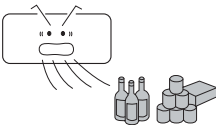



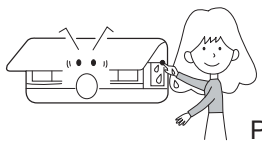

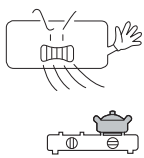

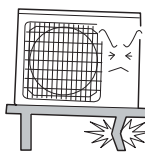
⚠ WARNING

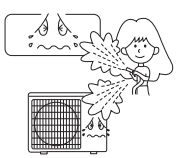
Please call Sales/Service Shop for the Installation.
Do not attempt to install the air conditioner by yourself because improper works may cause electric shock, fire, water leakage.

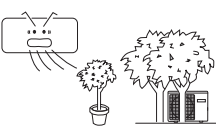
⚠ WARNING

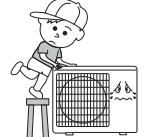

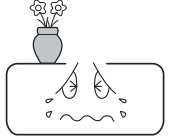

<p>When abnormality such as burnt-small found, immediately stop the operation button and contact sales shop.</p>  OFF   STRICT ENFORCEMENT	<p>Use an exclusive power source with a circuit breaker</p> 	<p>Check proper installation of the drainage securely</p>  STRICT ENFORCEMENT 	
<p>Connect power supply cord to the outlet completely</p>   STRICT ENFORCEMENT	<p>Use the proper voltage</p>   STRICT ENFORCEMENT	<p>1. Do not use power supply cord extended or connected in halfway 2. Do not install in the place where there is any possibility of inflammable gas leakage around the unit. 3. Do not get the unit exposed to vapor or oil steam.</p>  PROHIBITION	
<p>Do not use power supply cord in a bundle.</p>   PROHIBITION	<p>Take care not to damage the power supply cord.</p>   PROHIBITION	<p>Do not insert objects into the air inlet or outlet.</p>   PROHIBITION	
<p>Do not start or stop the operation by disconnecting the power supply cord and so on.</p>   PROHIBITION	<p>Do not channel the air flow directly at people, especially at infants or the aged.</p>   PROHIBITION	<p>Do not try to repair or reconstruct by yourself.</p> 	<p>Connect the earth cable.</p>  earthing

⚠ CAUTION

<p>Do not use for the purpose of storage of food, art work, precise equipment, breeding, or cultivation.</p>   PROHIBITION	<p>Take fresh air occasionally especially when gas appliance is running at the same time.</p>   STRICT ENFORCEMENT	<p>Do not operate the switch with wet hand.</p>   PROHIBITION
<p>Do not install the unit near a fireplace or other heating apparatus.</p>   PROHIBITION	<p>Check good condition of the installation stand</p>   PROHIBITION	<p>Do not pour water onto the unit for cleaning</p>   PROHIBITION
<p>Do not place animals or plants in the direct path of the air flow</p>   PROHIBITION	<p>Do not place any objects on or climb on the unit.</p>   PROHIBITION	<p>Do not place flower vase or water containers on the top of the unit.</p>   PROHIBITION

Trouble shooting

Before asking for service, check the following first.

	Phenomenon	Cause or check points
Normal Performance inspection	The system does not restart immediately. 	<ul style="list-style-type: none"> When unit is stopped, it won't restart immediately until 3 minutes have elapsed to protect the system. When the electric plug is pulled out and reinserted, the protection circuit will work for 3 minutes to protect the air conditioner.
	Noise is heard 	<ul style="list-style-type: none"> During unit operation or at stop, a swishing or gurgling noise may be heard. At first 2-3 minutes after unit start, this noise is more noticeable (This noise is generated by refrigerant flowing in the system.) During unit operation, a cracking noise may be heard. This noise is generated by the casing expanding or shrinking because of temperature changes. Should there be a big noise from air flow in unit operation, air filter may be too dirty.
	Smells are generated.	<ul style="list-style-type: none"> This is because the system circulates smells from the interior air such as the smell of furniture, paint, cigarettes.
	Mist or steam are blown out. 	<ul style="list-style-type: none"> During COOL or DRY operation, indoor unit may blow out mist. This is due to the sudden cooling of indoor air.
	In dry mode, fan speed can't be changed.	<ul style="list-style-type: none"> In DRY mode, when room temperature becomes lower than temp.setting+2°C, unit will run intermittently at LOW speed regardless of FAN setting.
Multiple check		<ul style="list-style-type: none"> Is power plug inserted? Is there a power failure? Is fuse blownout?
	Poor cooling 	<ul style="list-style-type: none"> Is the air filter dirty? Normally it should be cleaned every 15 days. Are there any obstacles before inlet and outlet? Is temperature set correctly? Are there some doors or windows left open? Is there any direct sunlight through the window during the cooling operation? (Use curtain) Are there too much heat sources or too many people in the room during cooling operation?

T1: Application temp. range of air conditioner -7°C~43°C.

T3: Application temp. range of air conditioner -7°C~54°C.

Cautions

The machine is adaptive in following situation

1. Applicable ambient temperature range:

For: T1			
Cooling	Indoor	Maximum: D.B / W.B	32°C/23°C
	Outdoor	Minimum: D.B / W.B	18°C/14°C
Heating	Indoor	Maximum: D.B	43°C/26°C
	Outdoor	Minimum: D.B	18°C
Cooling	Indoor	Maximum: D.B	27°C
	Outdoor	Minimum: D.B	15°C
Heating	Indoor	Maximum: D.B / W.B	24°C/18°C
	Outdoor	Minimum: D.B / W.B	-7°C/-8°C

For: T3			
Cooling	Indoor	Maximum: D.B / W.B	29°C/19°C
	Outdoor	Minimum: D.B / W.B	18°C/14°C
Heating	Indoor	Maximum: D.B / W.B	54°C/24°C
	Outdoor	Minimum: D.B	18°C
Cooling	Indoor	Maximum: D.B	27°C
	Outdoor	Minimum: D.B	15°C
Heating	Indoor	Maximum: D.B / W.B	24°C/18°C
	Outdoor	Minimum: D.B / W.B	-7°C/-8°C











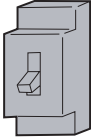
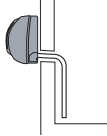

- If the supply cord is damaged, it must be replaced by the manufacturer or its service agent or a similar qualified person. The type of connecting wire is H05RN-F or H07RN-F
- If the fuse on PC board is broken please change it with a fuse type T. 3.15A/250V.
If the fuse of outdoor unit on PC board is broken, please change it with the type of T. 25A/250V.
- The distance between the indoor unit and the floor should be more than 2m.
- The wiring method should be in line with the local wiring standard.
- After installation, the power plug should be easily reached..
- The used batteries should be disposed of properly.
- The appliance is not intended to use by young children or infirm persons without supervision.
- Young children should be supervised ensure that they do not play with the appliance.
- The appliance must be installed on a strong enough support.
- The wiring diagram is attached inside the machine.

Cautions

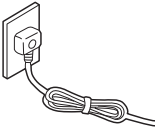
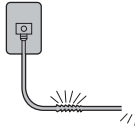
⚠ WARNING

Please call Sales/Service Shop for the Installation.
Do not attempt to install the air conditioner by yourself because improper works may cause electric shock, fire, water leakage.

⚠ WARNING

<p>When abnormality such as burnt-smell found, immediately stop the operation button and contact sales shop.</p>  <p>OFF</p>  <p>STRICT ENFORCEMENT</p>	<p>Use an exclusive power source with a circuit breaker</p> 	<p>Check proper installation of the drainage securely</p>  <p>STRICT ENFORCEMENT</p>	
<p>Connect power supply cord to the outlet completely</p>  <p>STRICT ENFORCEMENT</p>	<p>Use the proper voltage</p>  <p>STRICT ENFORCEMENT</p>	<p>1. Do not use power supply cord extended or connected in halfway 2. Do not install in the place where there is any possibility of inflammable gas leakage around the unit. 3. Do not get the unit exposed to vapor or oil steam.</p>  <p>PROHIBITION</p>	
<p>Do not use power supply cord in a bundle.</p>  <p>PROHIBITION</p>	<p>Take care not to damage the power supply cord.</p>  <p>PROHIBITION</p>	<p>Do not insert objects into the air inlet or outlet.</p>  <p>PROHIBITION</p>	
<p>Do not start or stop the operation by disconnecting the power supply cord and so on.</p>  <p>PROHIBITION</p>	<p>Do not channel the air flow directly at people, especially at infants or the aged.</p>  <p>PROHIBITION</p>	<p>Do not try to repair or reconstruct by yourself.</p> 	<p>Connect the earth cable.</p>  <p>earthing</p>

⚠ CAUTION

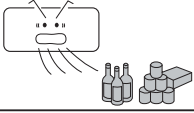
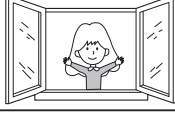
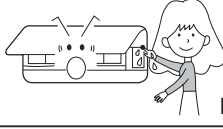
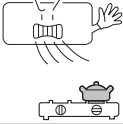
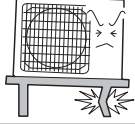
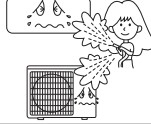
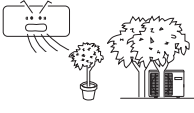
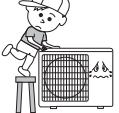
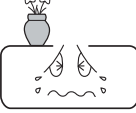
<p>Do not use for the purpose of storage of food, art work, precise equipment, breeding, or cultivation.</p>  <p>PROHIBITION</p>	<p>Take fresh air occasionally especially when gas appliance is running at the same time.</p>  <p>STRICT ENFORCEMENT</p>	<p>Do not operate the switch with wet hand.</p>  <p>PROHIBITION</p>
<p>Do not install the unit near a fireplace or other heating apparatus.</p>  <p>PROHIBITION</p>	<p>Check good condition of the installation stand</p>  <p>PROHIBITION</p>	<p>Do not pour water onto the unit for cleaning</p>  <p>PROHIBITION</p>
<p>Do not place animals or plants in the direct path of the air flow</p>  <p>PROHIBITION</p>	<p>Do not place any objects on or climb on the unit.</p>  <p>PROHIBITION</p>	<p>Do not place flower vase or water containers on the top of the unit.</p>  <p>PROHIBITION</p>

7. Codes and Description

7.1. Problem Symptoms and Measures

Symptom	Check Item	Details of Measure
None of the units operates	Check the power supply.	Check to make sure that the rated voltage is supplied.
	Check the indoor PCB	Check to make sure that the indoor PCB is broken
Equipment operates but does not cool, or does not heat (only for heat pump)	Diagnosis by service port pressure and operating current.	Check for insufficient gas.
Large operating noise and vibrations	Check the installation condition.	Check to make sure that the required spaces for installation (specified in the Technical Guide, etc.) are provided.

7.2 Error Codes and Description indoor display

	Code indication	Description	Reference Page
	indoor		
Indoor Malfunction	E1	Room temperature sensor failure	32
	E2	Heat-exchange sensor failure	32
	E4	Indoor EEPROM error	33
	E14	Indoor fan motor malfunction	34

The code indication that is listed above is the main fault

Troubleshooting

Caution: Be sure to turn off power switch before connect or disconnect connector, or else parts damage may be occurred.

E1: Room temperature sensor failure CN6

E2: Heat-exchange sensor failure CN6

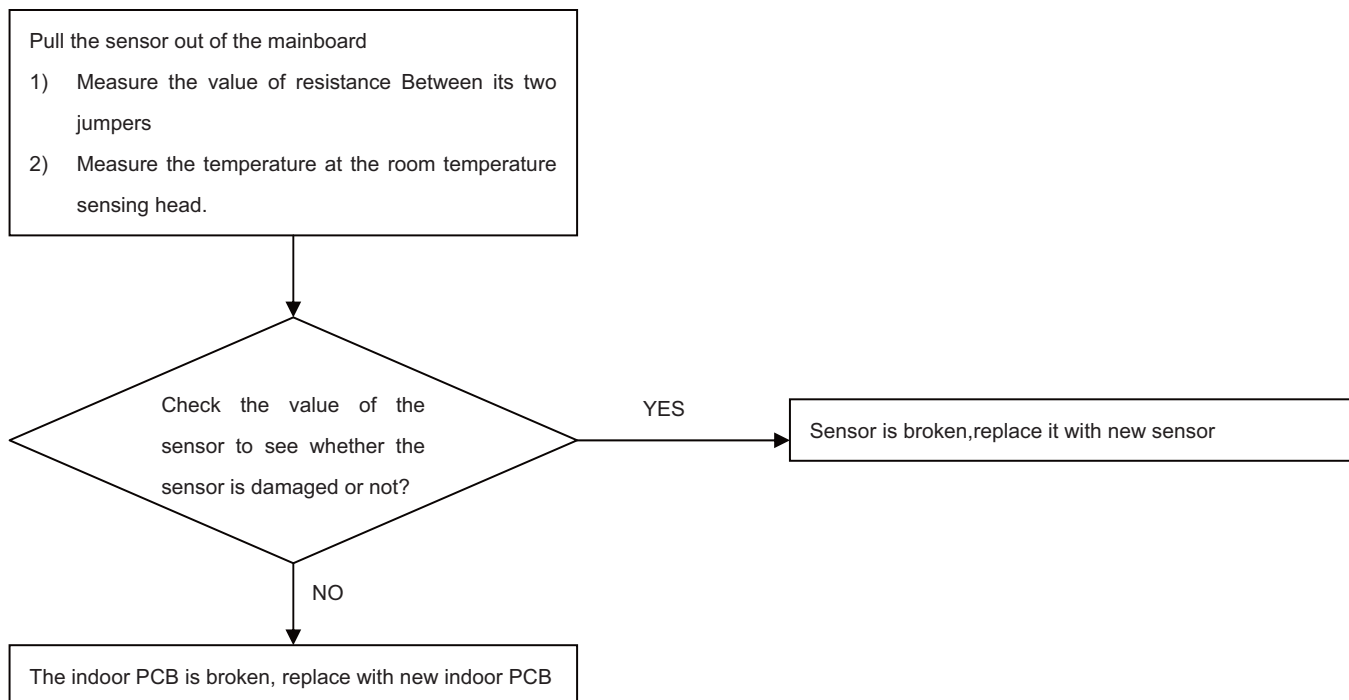

E4: Indoor EEPROM error:: Replace the PCB of indoor unit

E14 :Indoor fan motor malfunction

i Notes: When the unit is on ,don't pull out or insert the terminal of the motor (CN9), or else The motor would be damaged.

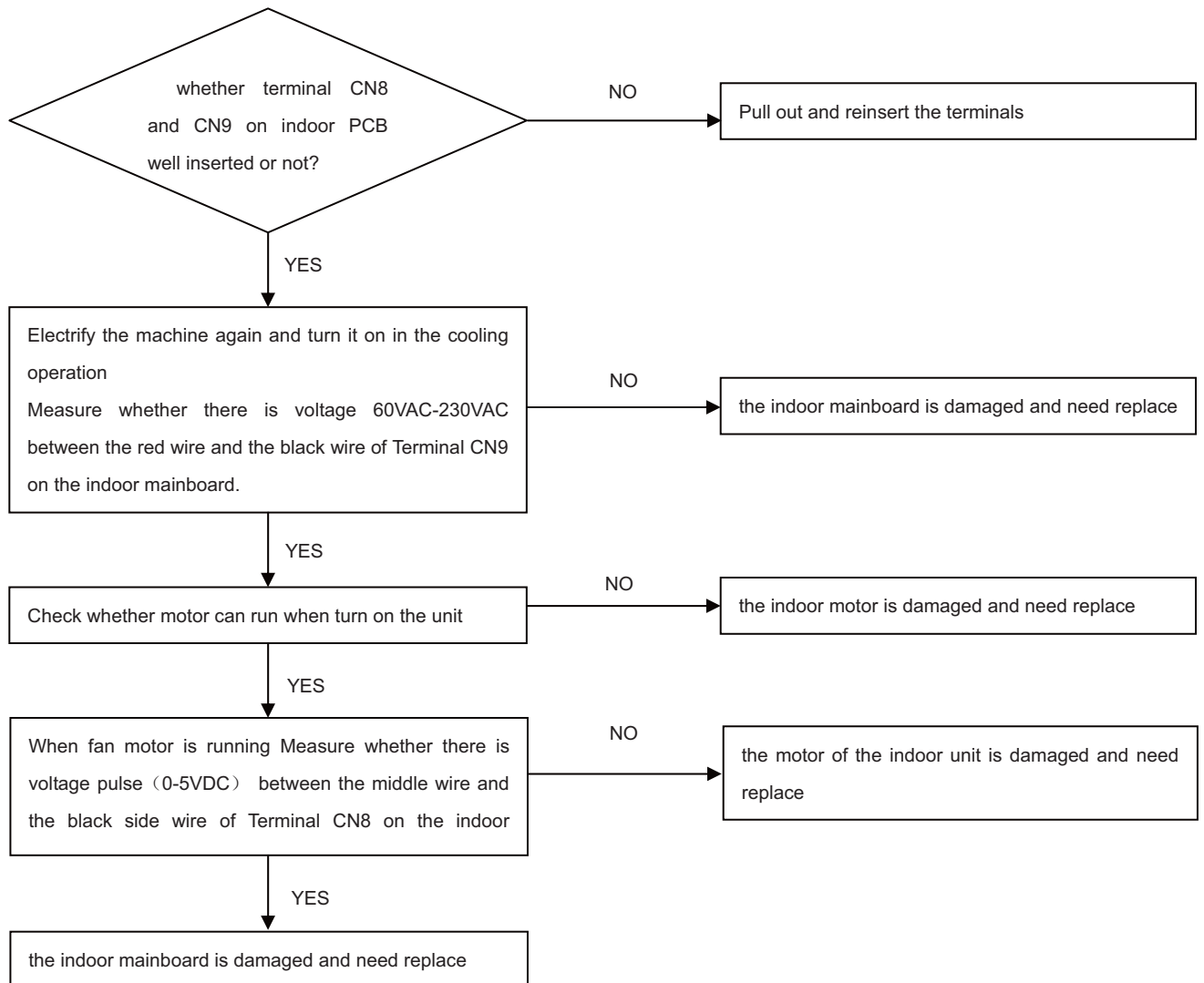

8. Capacity diagrams and curves diagrams

8.1 Cooling Capacity-temperature Curves

HSU-18HEK03 performance curves								
cooling capacity and indoor/outdoor temp.curves								
indoor temp.	outdoor temp.(humidity 46%)							
DB/WB	18°C	20°C	25°C	32°C	35°C	40°C	43°C	46°C
18/12°C	4593	4398	4354	4293	4298	4319	4045	3952
18/14°C	4833	4640	4623	4548	4529	4464	4208	3998
20/15°C	5075	4882	4839	4841	4760	4679	4411	4015
22/16°C	5049	4857	4815	4831	4745	4641	4371	4050
25/18°C	5022	4831	4791	4821	4727	4634	4372	4110
27/19°C	5152	4907	4882	4851	4800	4725	4463	4280
30/22°C	5291	5076	5061	4964	4899	4834	4540	4310
32/23°C	5345	5098	5064	4950	4921	4867	4602	4355
32/24°C	5381	5160	5103	4985	4956	4901	4635	4440

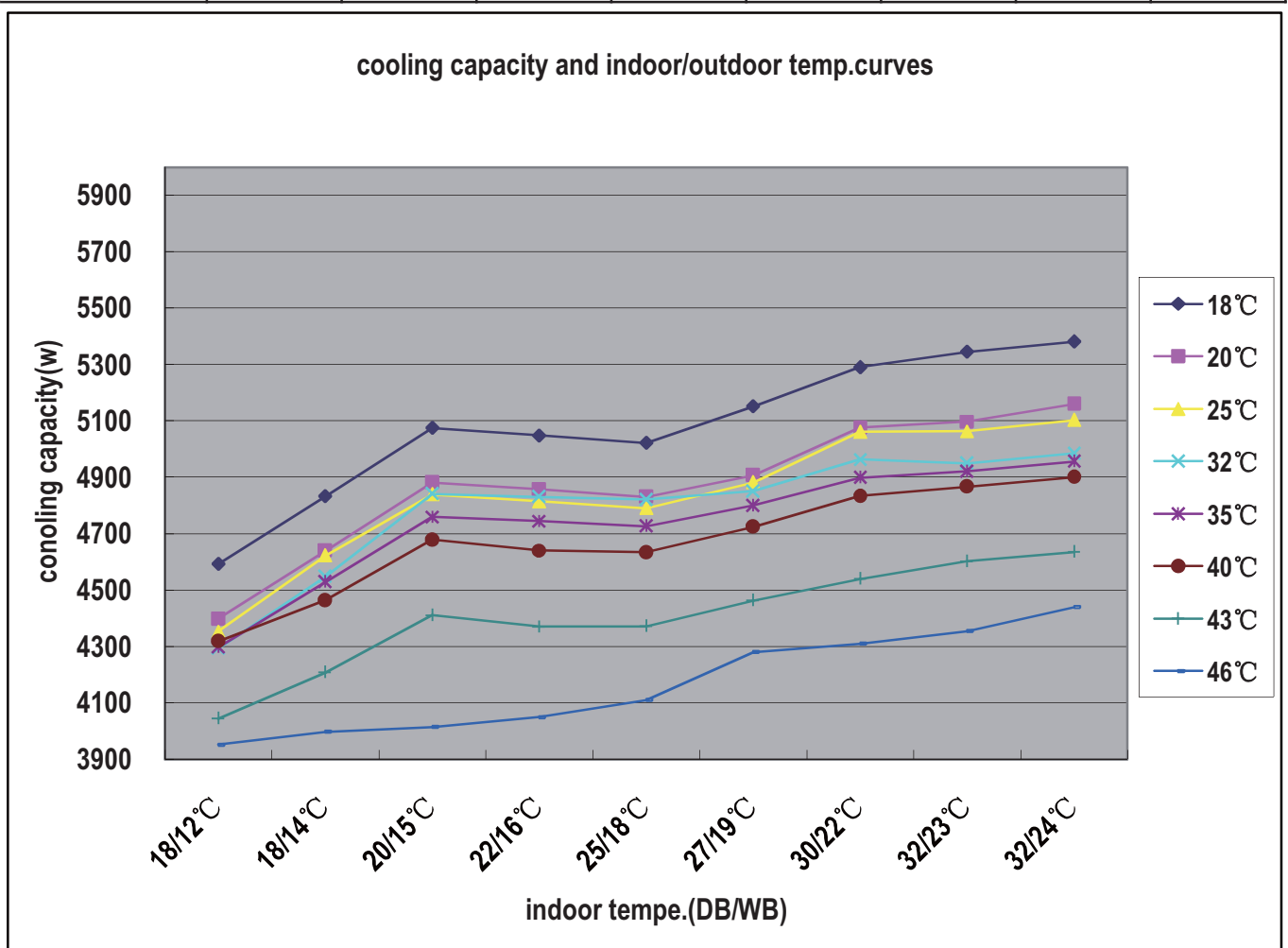

8.2 Heating Capacity-temperature Curves

HSU-18HEK03 performance curves			
heating capacity and indoor/outdoor temp.talbe			
outdoor temp.	indoor temp.(humidity 46%)		
DB/WB	15°C	20°C	25°C
-10°C	3045	2972	2875
-5°C	3884	3798	3675
5°C	4284	4196	4069
7/6°C	4799	5200	4328
15°C	5300	5350	5100
20°C	5600	5500	5400
25°C	6100	5850	5600

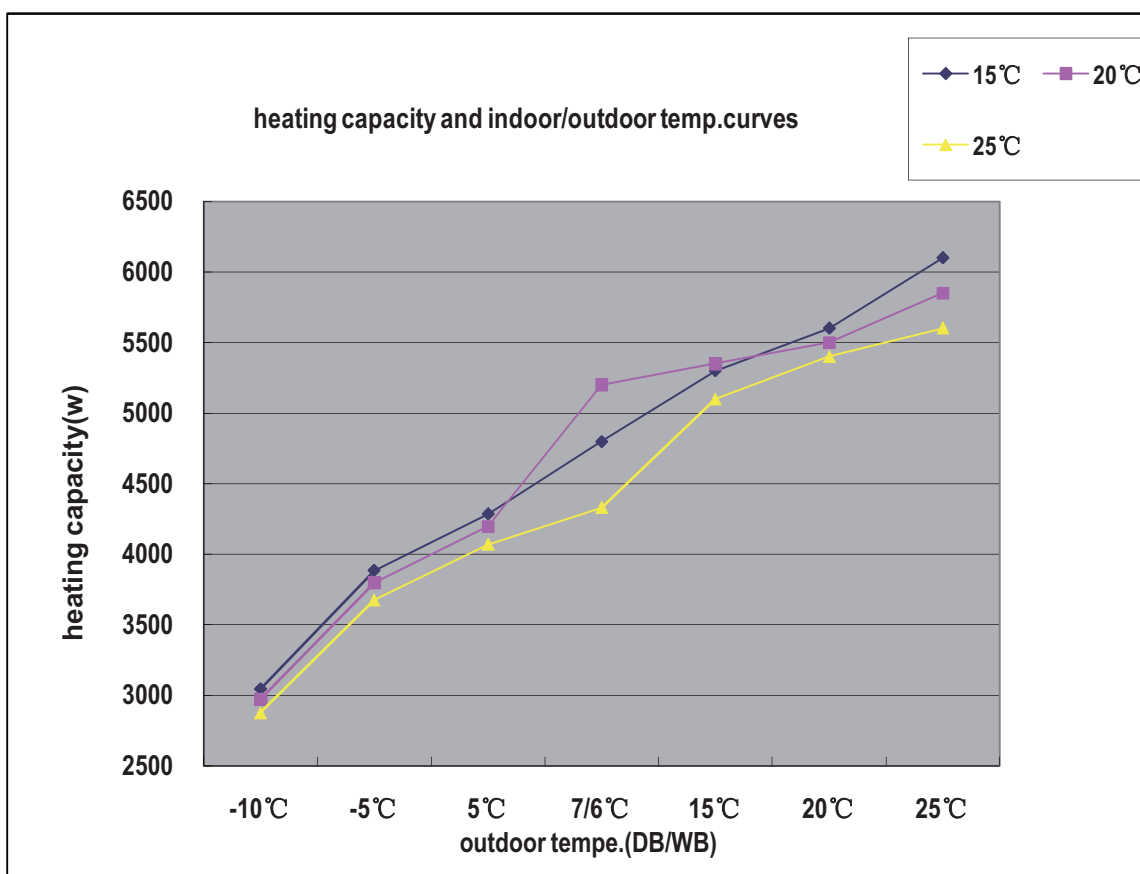

8.3 Sensible cooling value-temperature curves

HSU-18HEK03 performance curves								
sensible cooling value-temperature talbe								
indoor temp.	outdoor temp.(humidity 46%)							
DB/WB	18°C	20°C	25°C	32°C	35°C	40°C	43°C	46°C
18/12°C	1857	1783	1720	1647	1489	1400	1315	1236
18/14°C	1936	1866	1789	1752	1545	1489	1360	1273
20/15°C	1982	1920	1845	1807	1634	1536	1408	1315
22/16°C	2061	1969	1935	1870	1691	1562	1445	1347
25/18°C	2137	2066	2003	1961	1774	1667	1491	1400
27/19°C	2205	2132	2063	2020	1819	1713	1570	1459
30/22°C	2284	2261	2192	2147	1941	1769	1630	1523
32/23°C	2430	2380	2260	2181	2043	1834	1699	1562
32/24°C	2454	2404	2320	2265	2131	1920	1723	1629

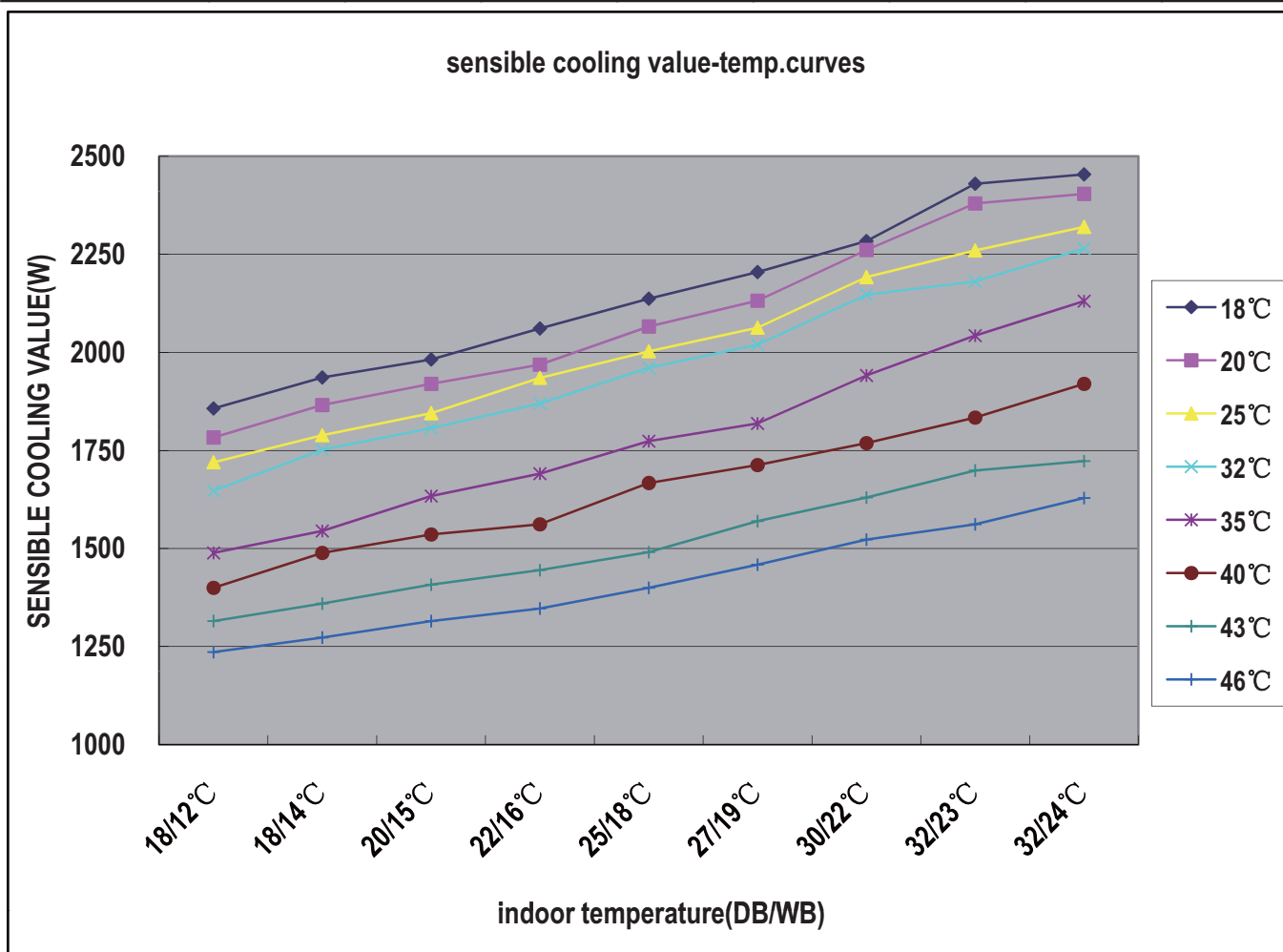

8.4 Cooling Power Consumption Value-temperature Curves

HSU-18HEK03 performance curves								
power consumption value-temperature								
indoor temp.	outdoor temp.(humidity 46%)							
DB/WB	18°C	20°C	25°C	32°C	35°C	40°C	43°C	46°C
18/12°C	1428	1487	1565	1720	1792	2087	2185	2104
18/14°C	1433	1492	1571	1726	1798	2096	2195	2114
20/15°C	1456	1517	1597	1755	1828	2130	2231	2148
22/16°C	1476	1538	1619	1779	1853	2154	2254	2171
25/18°C	1496	1559	1641	1803	1878	2180	2282	2196
27/19°C	1514	1577	1660	1824	1900	2205	2307	2222
30/22°C	1542	1606	1690	1858	1935	2234	2334	2248
32/23°C	1566	1631	1717	1886	1965	2291	2400	2311
32/24°C	1571	1648	1730	1904	1985	2305	2412	2323

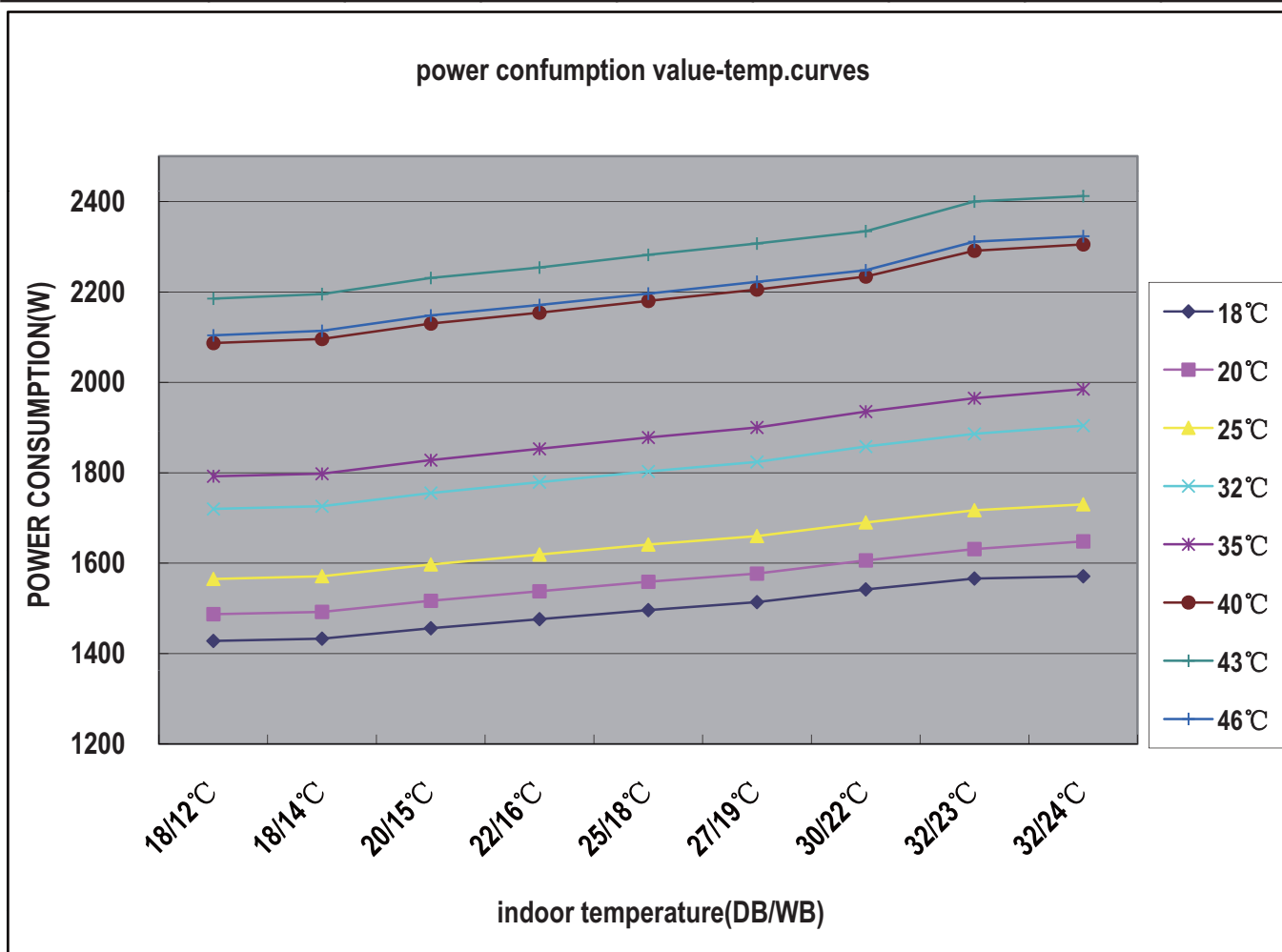

8.5 Heating Power Consumption Value-temperature Curves

HSU-18HEK03 performance curves			
power consumption value-teme.talbe			
DB/WB	15°C	20°C	25°C
-10°C	1342	1380	1423
-5°C	1411	1450	1580
5°C	1430	1520	1600
7/6°C	1620	1650	1720
15°C	1520	1550	1600
20°C	1280	1320	1540
25°C	1250	1280	1430

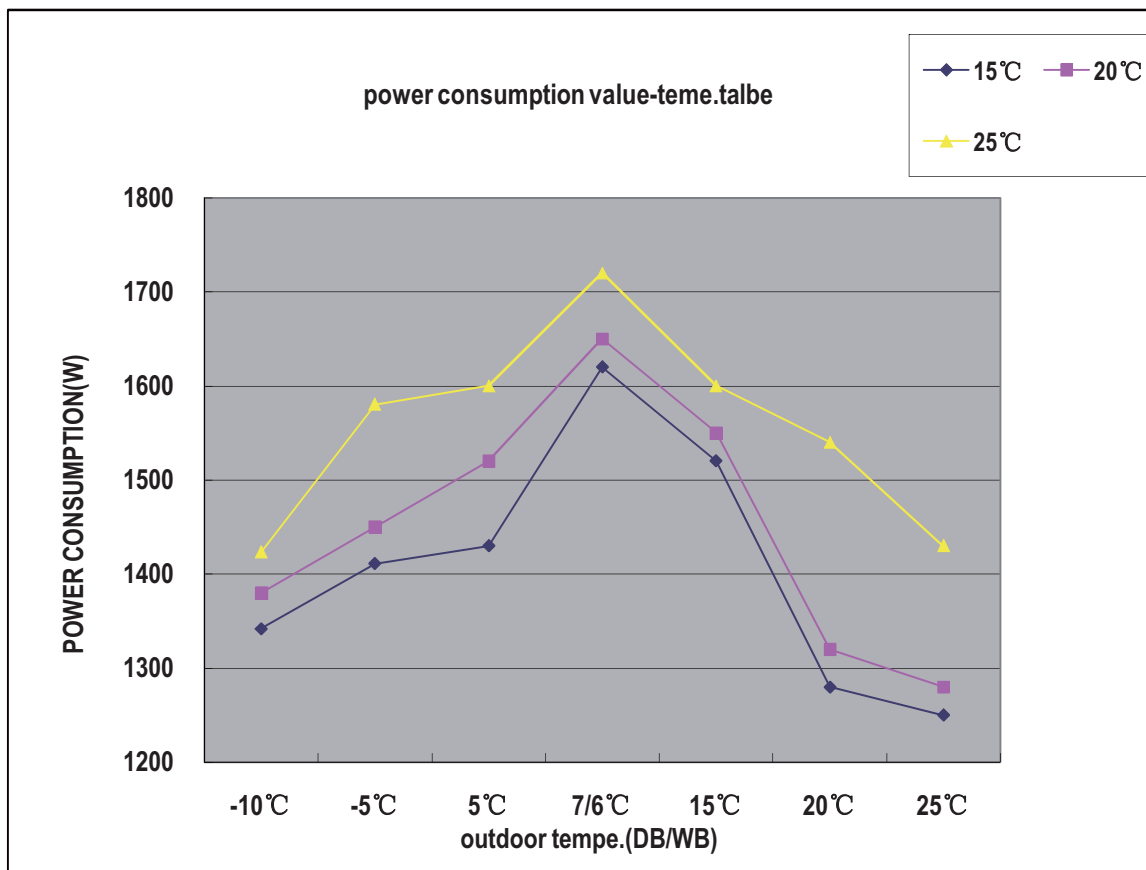

8.6 Air outlet Value-temperature Curves

HSU-18HEK03 performance curves								
air outlet temp.-ambient teme.talbe								
indoor temp.	outdoor temp.(humidity 46%)							
DB/WB	18°C	20°C	25°C	32°C	35°C	40°C	43°C	46°C
18/12°C	7.07	7.27	7.57	8.07	8.87	9.37	9.67	9.87
18/14°C	7.71	7.91	8.21	8.71	9.51	10.01	10.31	10.51
20/15°C	8.87	9.07	9.37	9.87	10.67	11.17	11.47	11.67
22/16°C	9.80	10.00	10.30	10.80	11.60	12.10	12.40	12.60
25/18°C	10.51	10.71	11.01	11.51	12.31	12.81	13.11	13.31
27/19°C	11.19	11.39	11.69	12.19	12.99	13.49	13.79	13.99
30/22°C	11.65	11.85	12.15	12.65	13.45	13.95	14.25	14.45
32/23°C	11.79	11.99	12.29	12.79	13.59	14.09	14.39	14.59
32/24°C	11.84	12.04	12.34	12.84	13.64	14.14	14.44	14.64

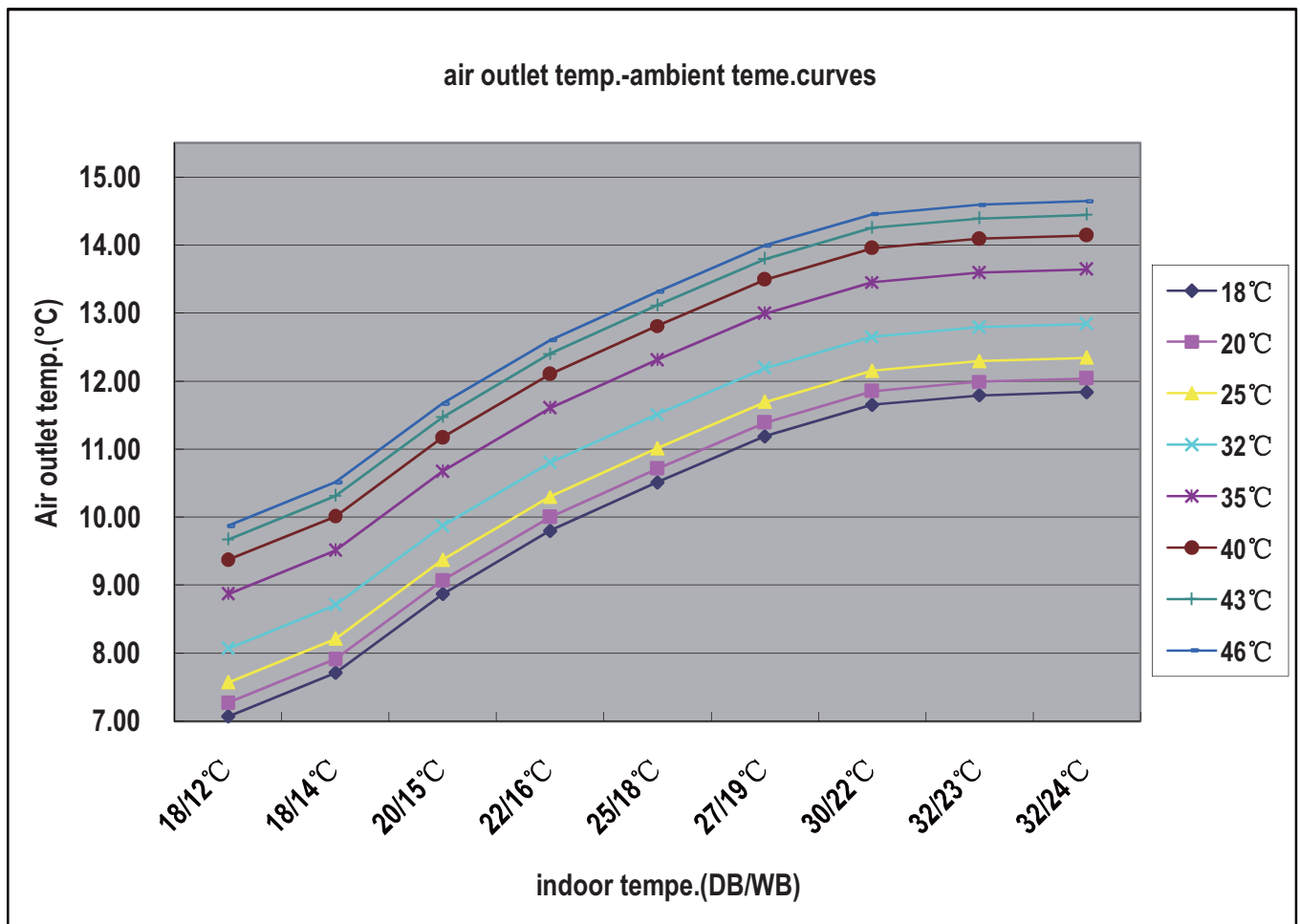

8.7 Cooling Discharge Pressure Curves

HSU-18HEK03 performance curves			
COOLING DISCHARGE PRESSURE.talbe			
outdoor temp. (humidity 46%)	indoor temp.		
DB/WB	16°C	19°C	22°C
15°C	2240	2360	2540
25°C	2530	2640	2720
30°C	2864	2990	3190
35°C	3180	3290	3480
40°C	3310	3490	3620
45°C	3400	3573	3680

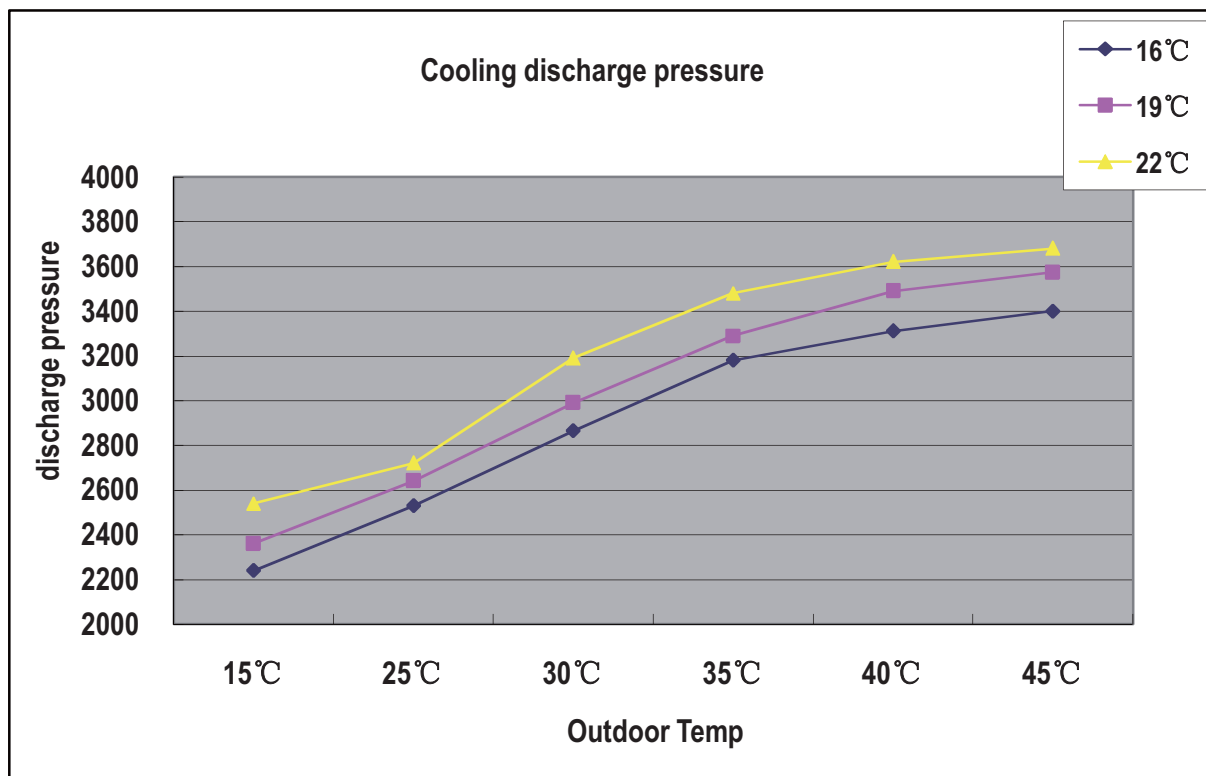

8.8 Heating Discharge Pressure Curves

HSU-18HEK03 performance curves			
HEATING DISCHARGE PRESSURE.talbe			
outdoor temp. (humidity 46%)	indoor temp.		
DB/WB	15°C	20°C	25°C
-15°C	2003	2171	2336
-10°C	2069	2260	2482
-5°C	2324	2440	2649
0°C	2290	2460	2661
5°C	2499	2630	2755
10°C	2819	2962	3267
15°C	3316	3499	3567
20°C	2957	3330	3500

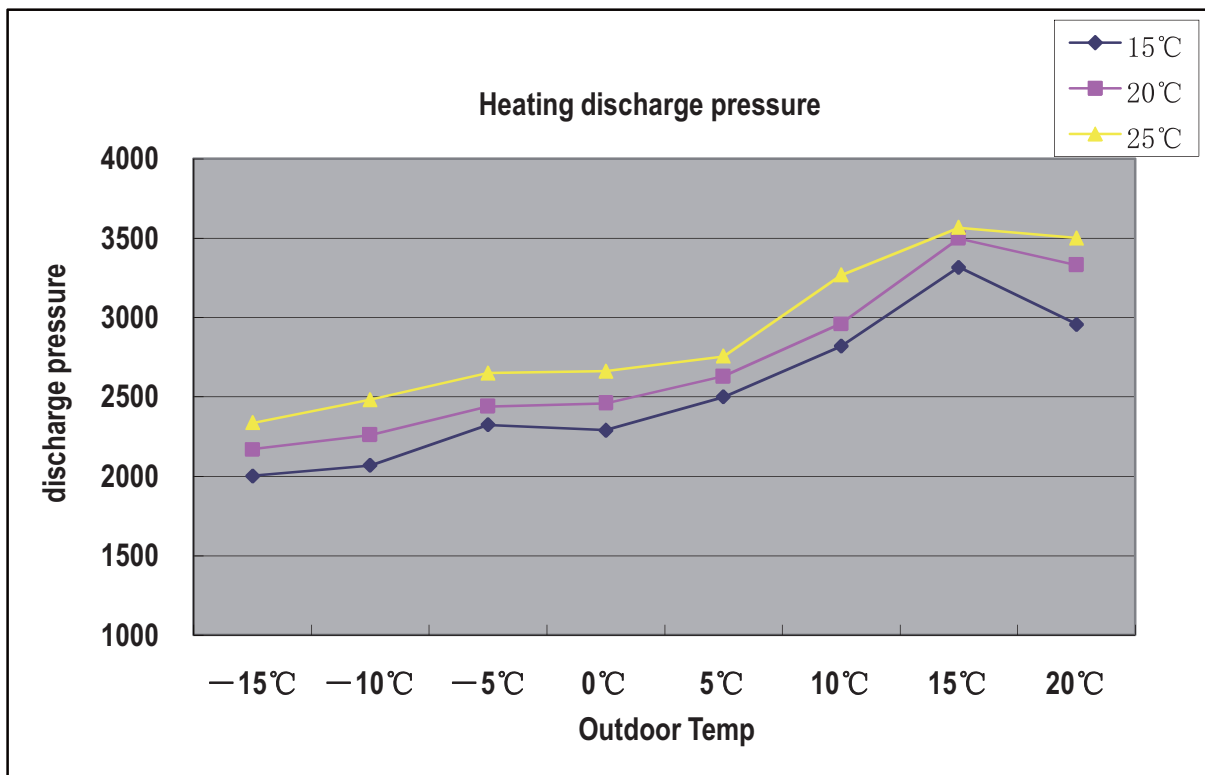

8.9 Cooling Suction Pressure Curves

HSU-18HEK03 performance curves			
COOLING SUCTION PRESSURE table			
outdoor temp. (humidity 46%)	indoor temp.		
	16°C	19°C	22°C
DB/WB			
15°C	646	734	746
25°C	675	754	758
30°C	678	759	757
35°C	688	762	778
40°C	726	804	820
45°C	754	836	851

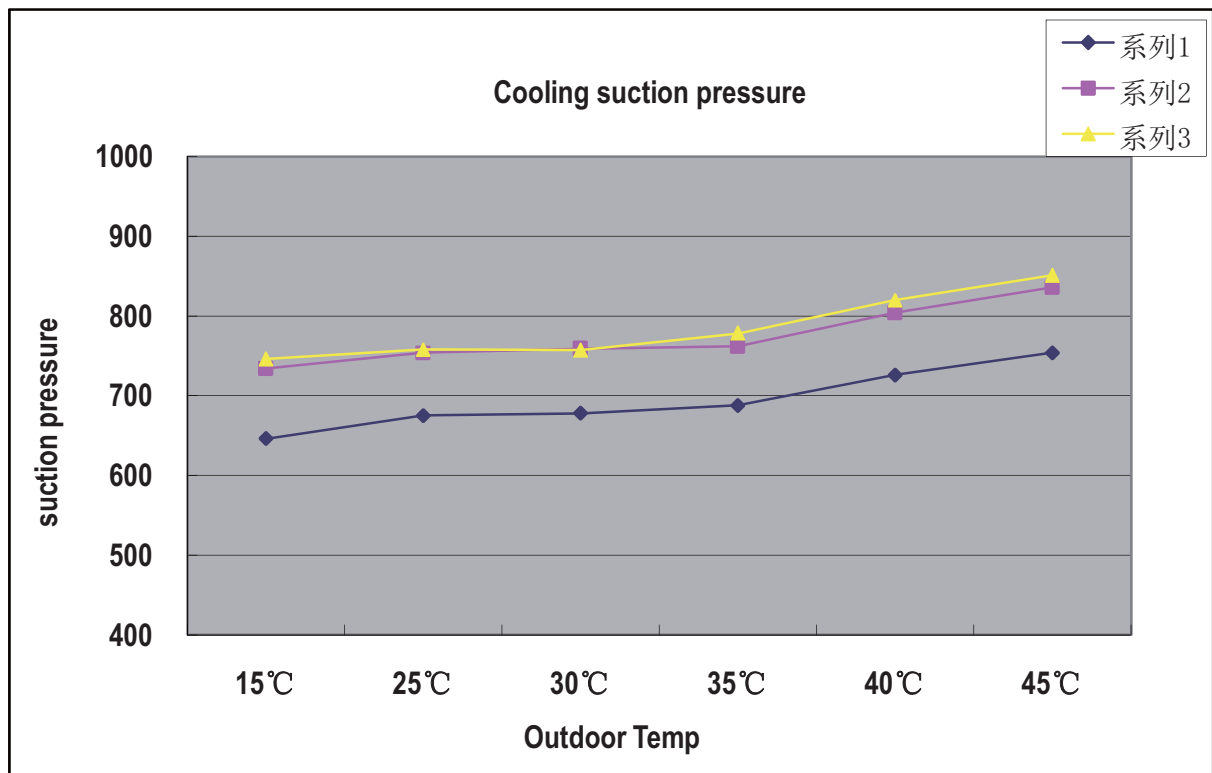

8.10 Heating Suction Pressure Curves

HSU-18HEK03 performance curves			
HEATING SUCTION PRESSURE table			
outdoor temp. (humidity 46%)	indoor temp.		
DB/WB	15°C	20°C	25°C
-15°C	240	239	242
-10°C	305	310	320
-5°C	374	395	400
0°C	410	450	458
5°C	450	520	525
10°C	580	628	662
15°C	737	737	798
20°C	699	729	742

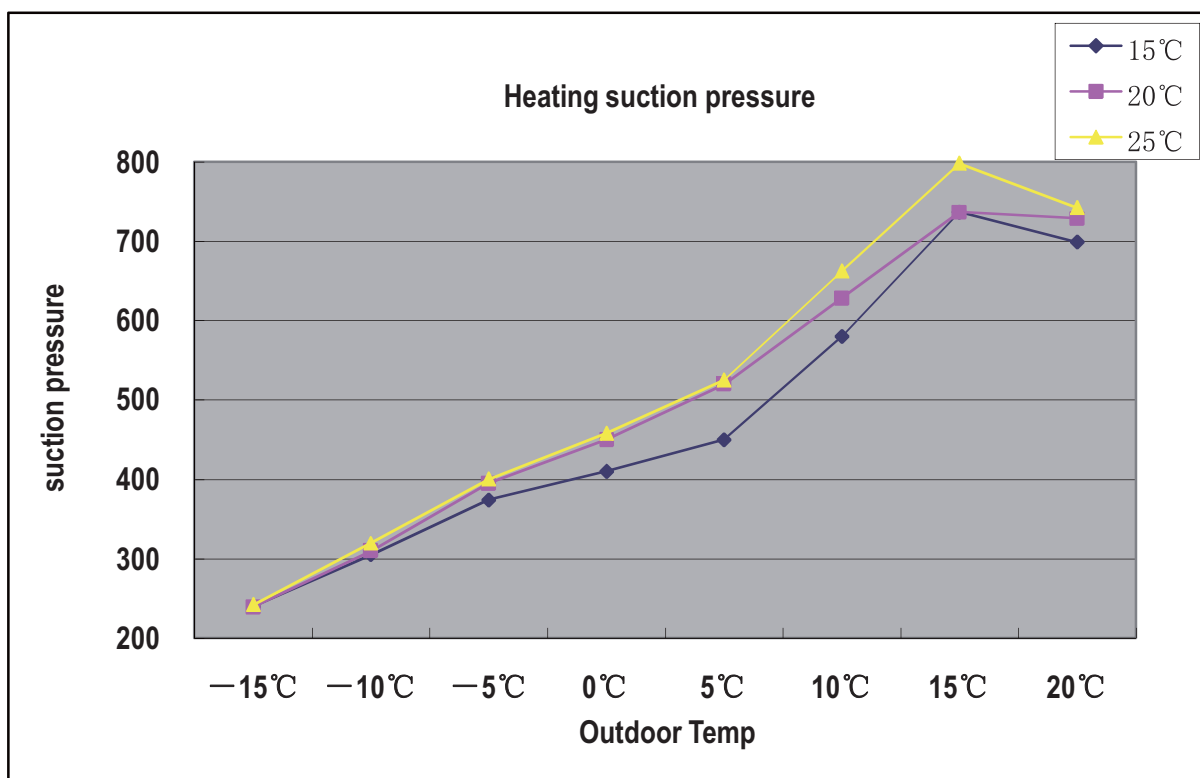

9. Installations

Installation Manual of Room Air Conditioner

- Read this manual before installation
- Explain sufficiently the operating means to the user according to this manual.

Necessary Tools for Installation

- | | | | |
|---------------------------|---------------------------------|--|-----------|
| 1.Driver | 5.Torque wrench(17mm,22mm,26mm) | 9.Nipper | 12.Reamer |
| 2.Hacksaw | 6.Pipe cutter | 10.Gas leakage detector or soap-and-water solution | |
| 3.Hole core drill | 7.Flaring tool | 11.Measuring tape | |
| 4.Spanner(17,19 and 26mm) | 8.Knife | | |

Drawing for the installation of indoor and outdoor units

Accessory parts

No.	Accessory parts	Number of articles
①	Remote controller	1
②	R-03 dry battery	2
③	Mounting plate	1
④	Drain hose	1
⑤	Φ4X50 Steel nail, cement	6
⑥	Φ4X25 Screw Plastic cap	4
⑦	Drain-elbow	1
⑧	Cover	1
⑨	Cushion	4
⑩	Pipe supporting plate	1
⑪	Connecting cable	1

Optional parts for piping

Mark	Parts name
(A)	Non-adhesive tape
(B)	Adhesive tape
(C)	Saddle(L.S) with screws
(D)	Connecting electric cable for indoor and outdoor
(E)	Drain hose
(F)	Heating insulating material
(G)	Piping hole cover

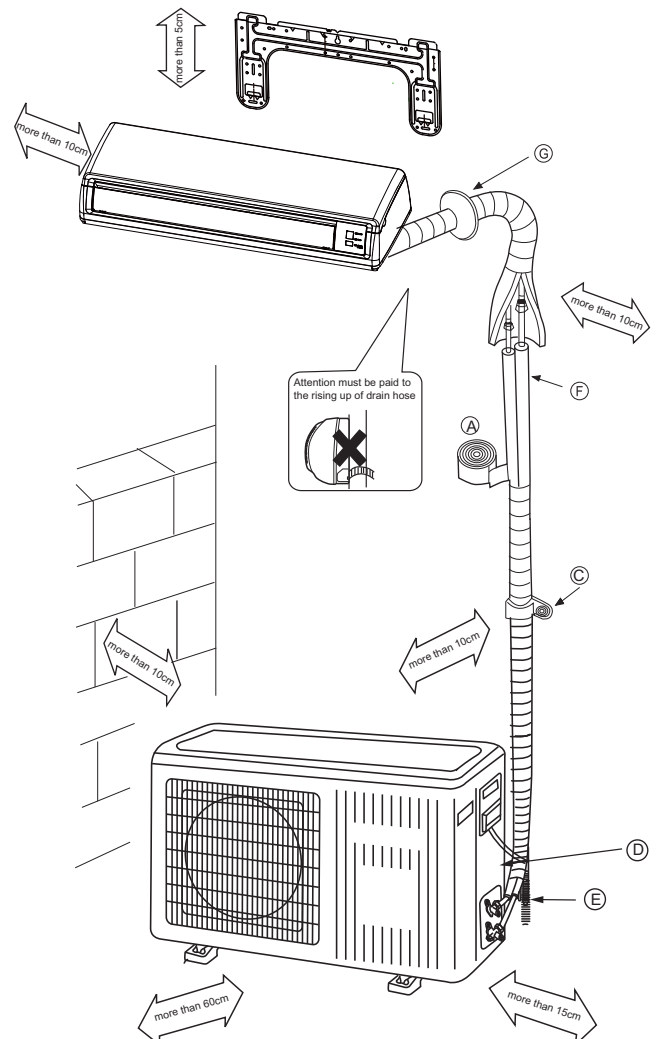
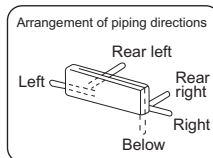

Note: Cooling only units don't have Drain-elbow

- ※ The marks from (A) to (G) in the figure are the parts numbers.
- ※ The distance between the indoor unit and the floor should be more than 2m.

Indoor unit

Connecting the indoor/outdoor Electric Cable

Removing the wiring cover

- Remove terminal cover at right bottom corner of indoor unit, then take off wiring cover by removing its screws.

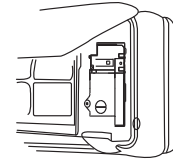

When connecting the cable after installing the indoor unit

- Insert from outside the room cable into left side of the wall hole, in which the pipe has already existed.
- Pull out the cable on the front side, and connect the cable making a loop.

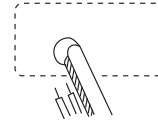

When connecting the cable before installing the indoor unit

- Insert the cable from the back side of the unit, then pull it out on the front side.
- Loosen the screws and insert the cable ends fully into terminal block, then tighten the screws.
- Pull the cable slightly to make sure the cables have been properly inserted and tightened.
- After the cable connection, never fail to fasten the connected cable with the wiring cover.

Note: When connecting the cable, confirm the terminal number of indoor and outdoor units carefully. If wiring is not correct, proper operation can not be carried out and will cause defect.

- If the supply cord is damaged, it must be replaced by the manufacturer or its service agent or a similar qualified person. The type of connecting wire is H05/07RN-F or 245IEC57(YZW).
- If the fuse on PC board is broken please change it with the type of T. 3.15A/250V.
If the fuse of outdoor unit on PC board is broken, please change it with the type of T. 25A/250V.
- The wiring method should be in line with the local wiring standard.
- After installation, the power plug should be easily reached.
- A breaker should be incorporated into fixed wiring. The breaker should be all-pole switch and the distance between its two contacts should be not less than 3mm.

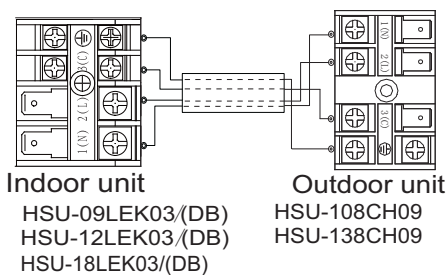

connecting wiring:

- mod 09-12: $\geq 3G1.5mm^2 + 1X0.75mm^2$
- mod 18: $\geq 4G0.75mm^2$

Power cable:

- mod 09-12: $\geq 3G1.0mm^2$
- mod 18: $\geq 3G1.5mm^2$

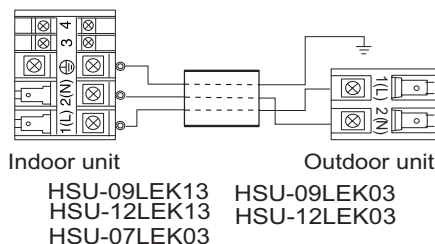
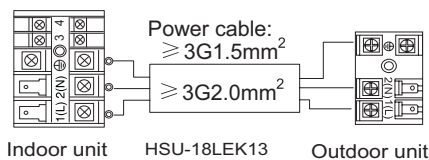
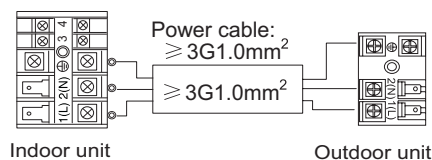
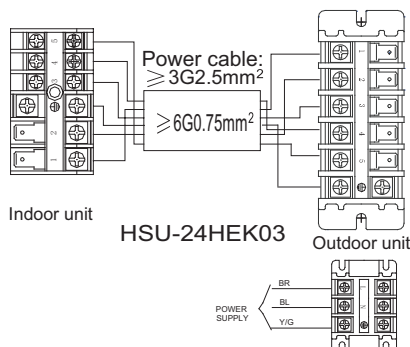

connecting wiring:

- mod 07-12: $\geq 3G1.0mm^2$
- Power cable:
- mod 07-12: $\geq 3G1.0mm^2$

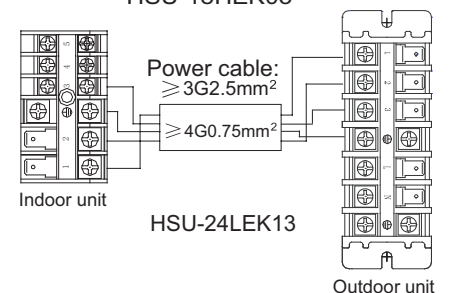
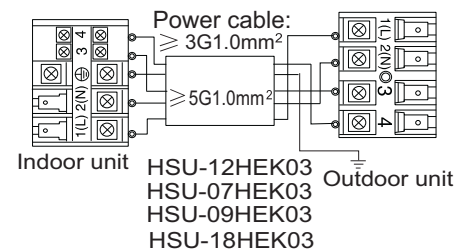

Outdoor unit

Outdoor unit

1. Connection of pipes

- To bend a pipe, give the roundness as large as possible not to crush the pipe
- Connecting the pipe of gas side first makes working easier.
- The max vertical distance between the indoor unit and the outdoor unit is 5 m.

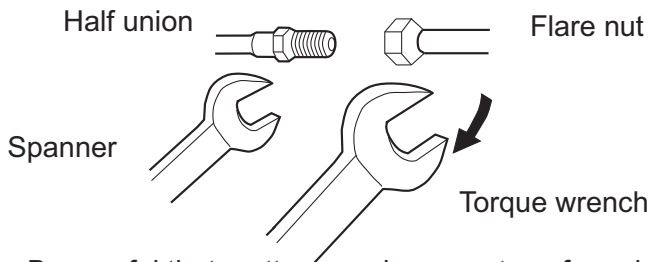

Be careful that matters, such as wastes of sands, etc. shall not enter the pipe.

Forced fastening without careful centering may damage the threads and cause a leakage of gas.

Pipe Diameter (ϕ)	Fastening torque
Liquid side 6.35mm(1/4")	18N.m
Liquid side 9.52mm(3/8")	40N.m
Gas side 9.52mm(3/8")	40N.m
Gas side 12.7mm(1/2")	50N.m
Gas side 15.88mm(5/8")	60N.m

2. Attaching Drain-Elbow

- If the drain-elbow is used, please attach it as figure. (Note: Only for heat pump unit.)

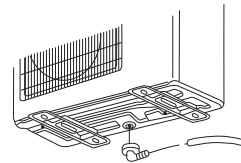

3. Purging Method:

Push the air out of the indoor unit and piping as follows:

- Tighten the caps on the valves with specified torque.

	Tighten torque N.m
Valve rod	7-9
Valve cap	20-25

- When connecting pipe exceeds 5 meters, 20g or 60g(only for 22k 24k) refrigerant shall be added per exceeding meter. Charge according to the following list.

	for 5k 7k 9k 10k 12k 13k 18k			for 22k 24k				
Piping length	5m	7m	10m	Piping length	5m	7m	10m	20m
Additional amount	No need	40g	100g	Additional amount	No need	120g	300g	900g

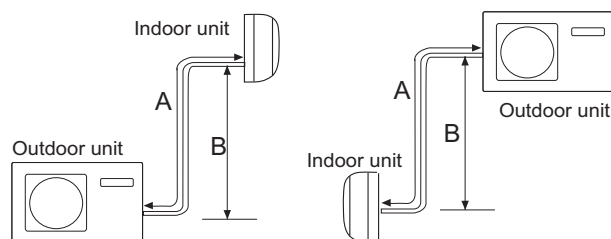

Max.Elevation: for 5K 7K 9K 10K 12K 13K: B=5m
for 18K 22K 24K: B=10m

Max. Length: for 5K 7K 9K 10K: A=7m
for 12K 13K: A=10m
for 18K 22K 24K: A=20m

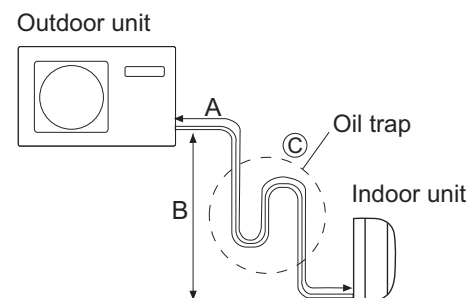

CAUTION

- In case more than 5 metres, oil trap © should be installed every 5~7m.

10. Appendix

10.1 Piping Diagrams

Cooling mode

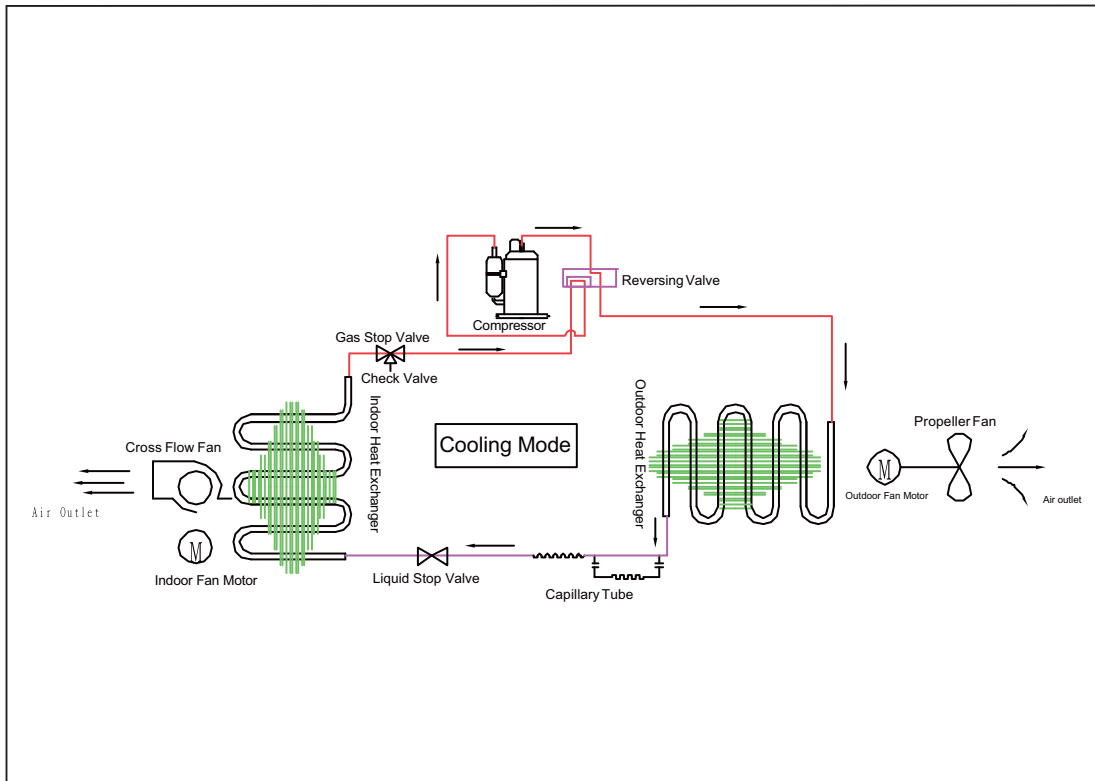

Heating mode

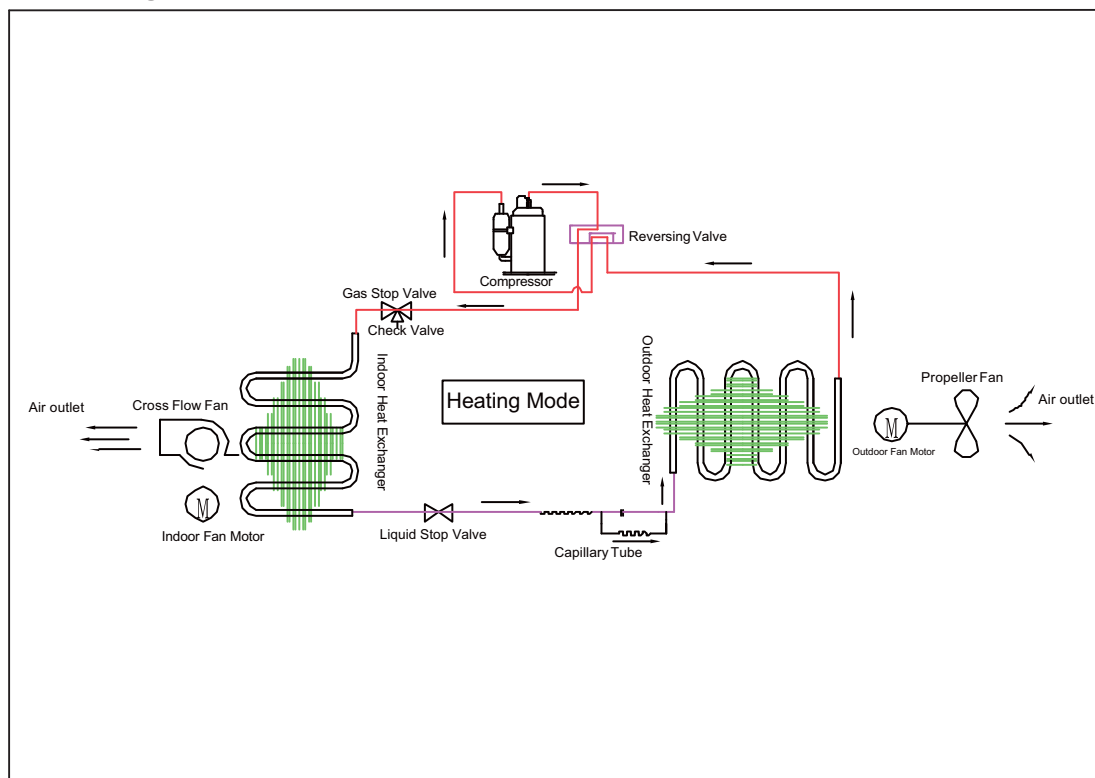

10.2 Wiring Diagrams

Indoor

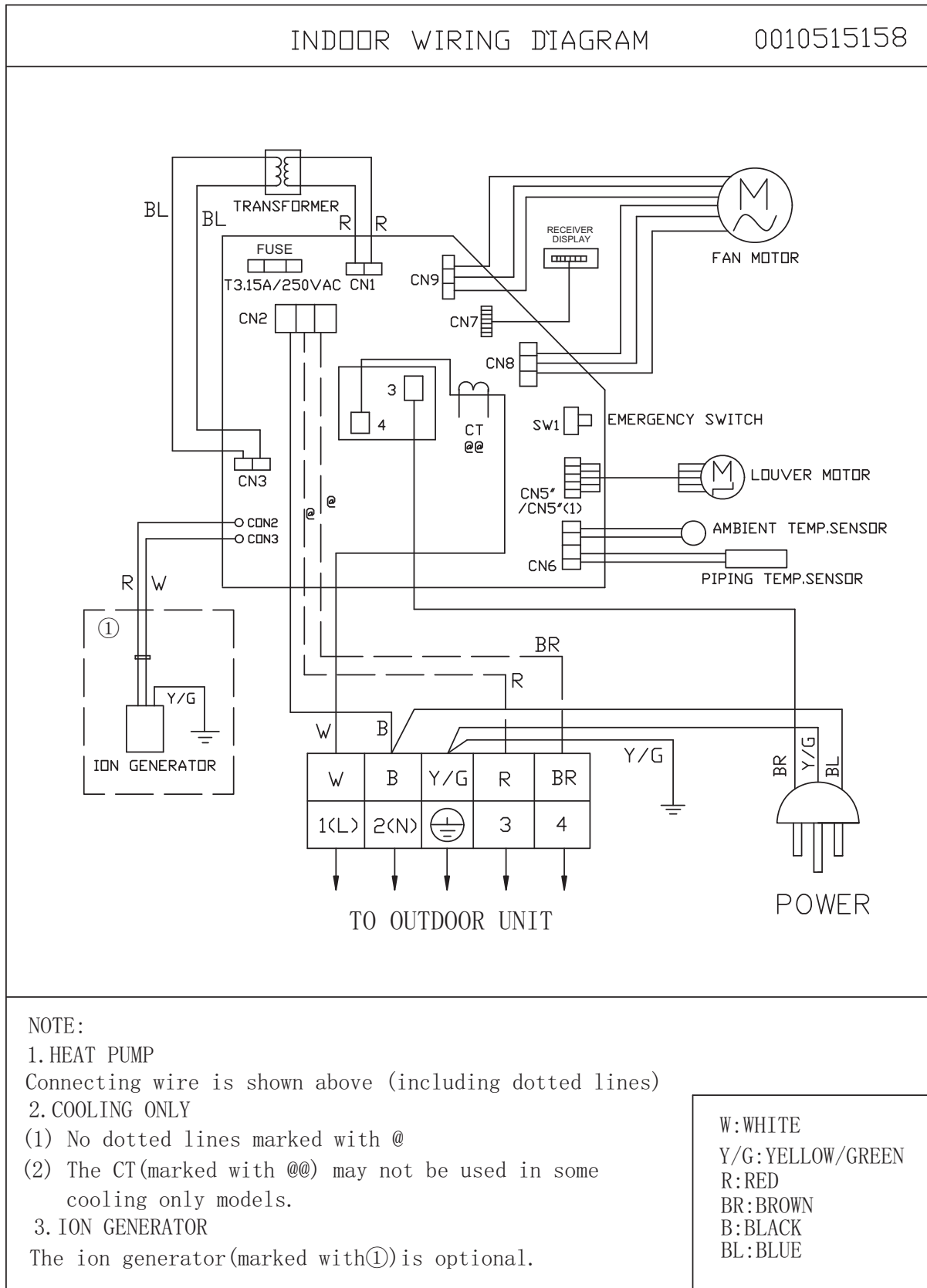

Outdoor

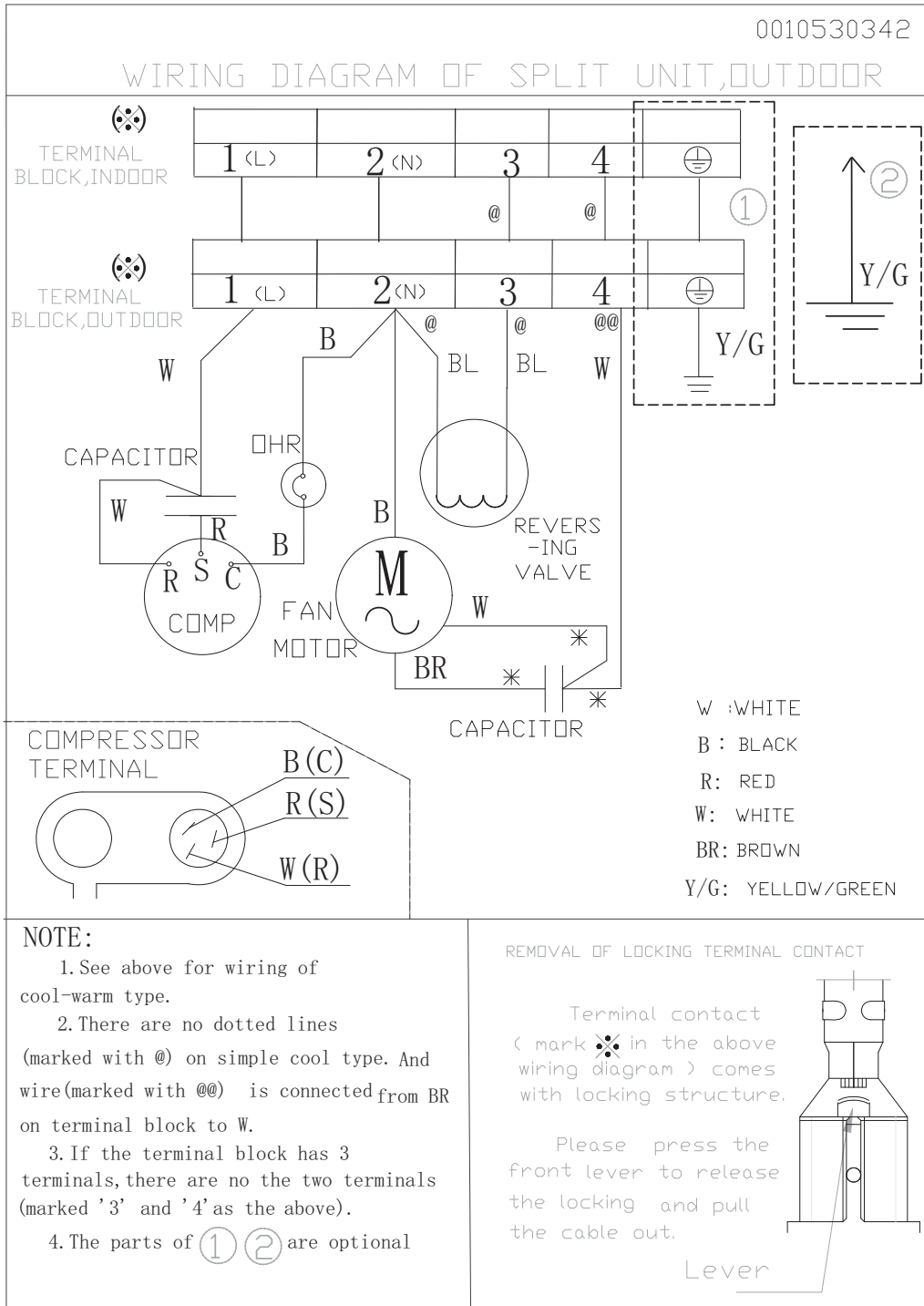

10.3 Circuit Diagrams

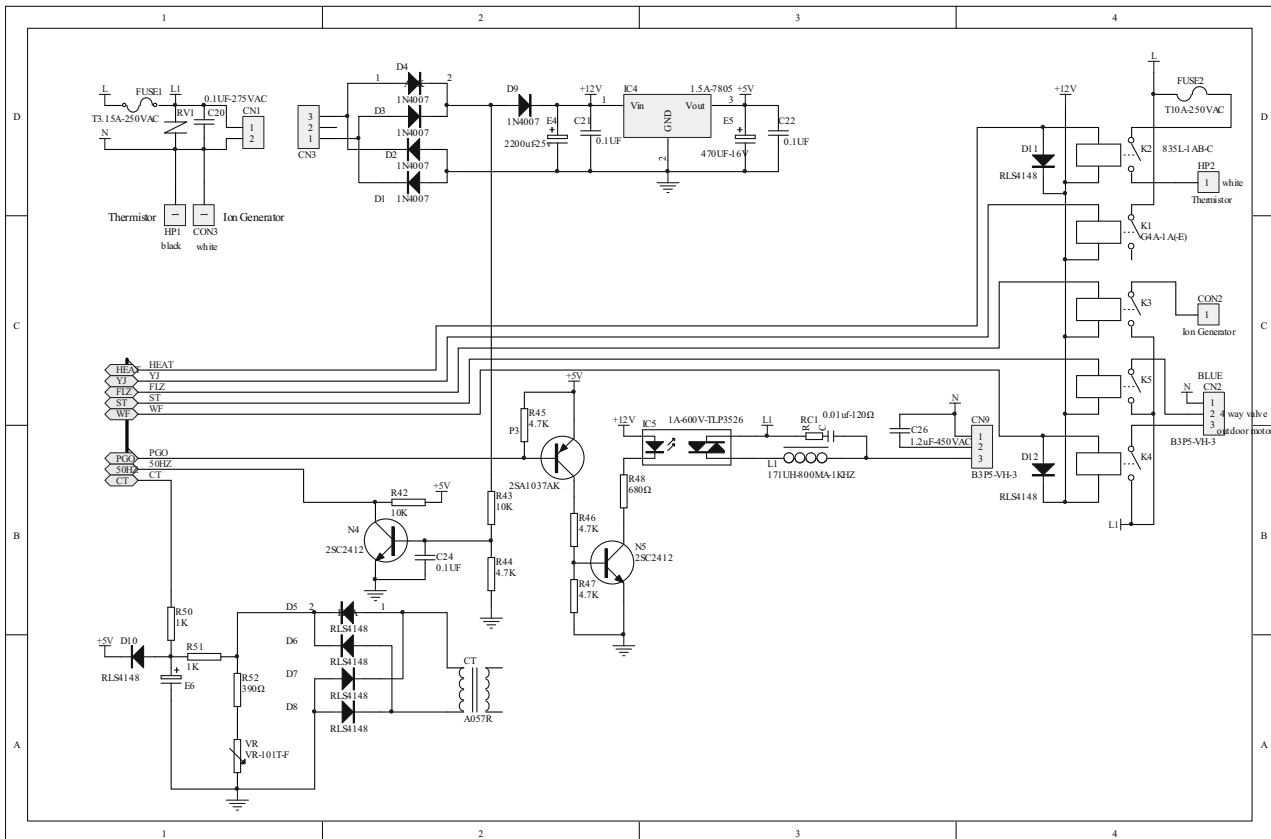
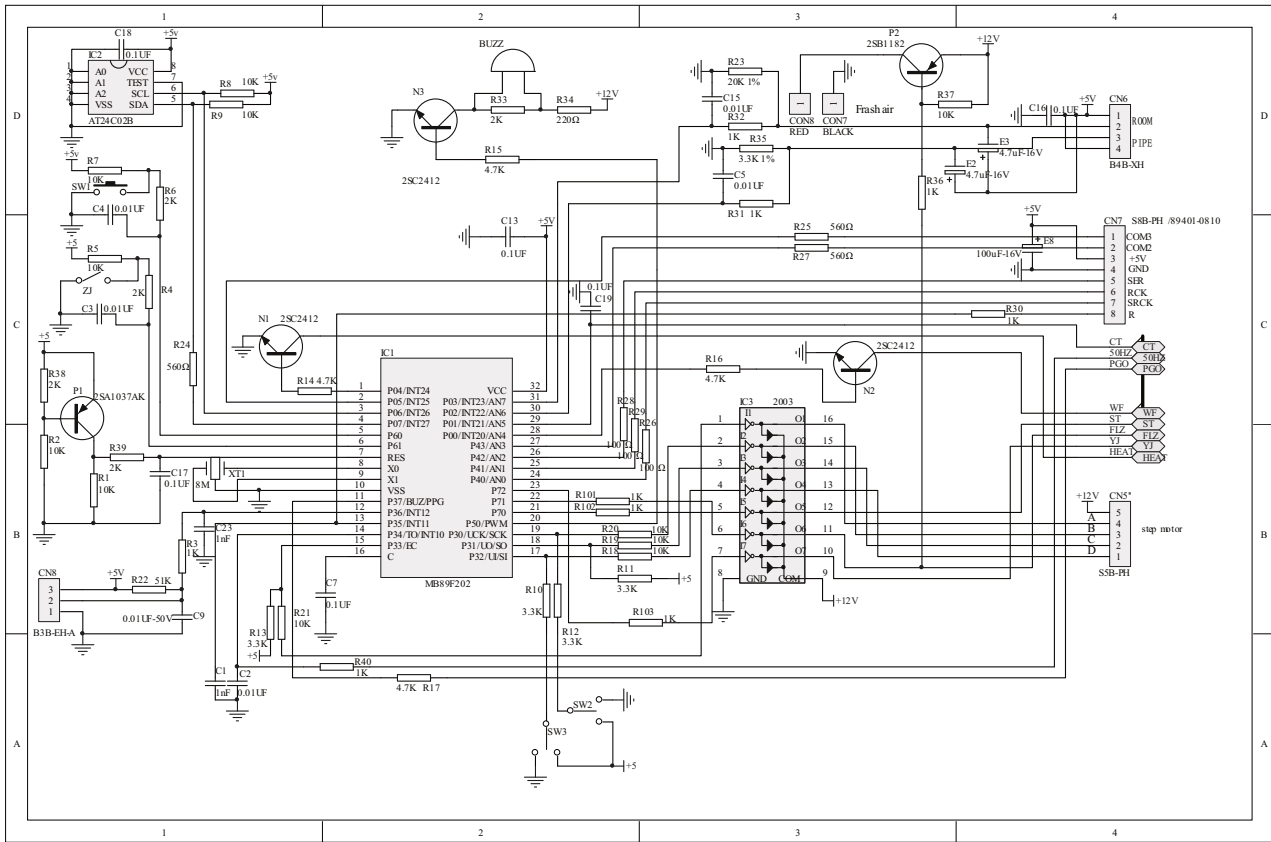

10.4 Dimensional drawings and center of gravity

Indoor unit

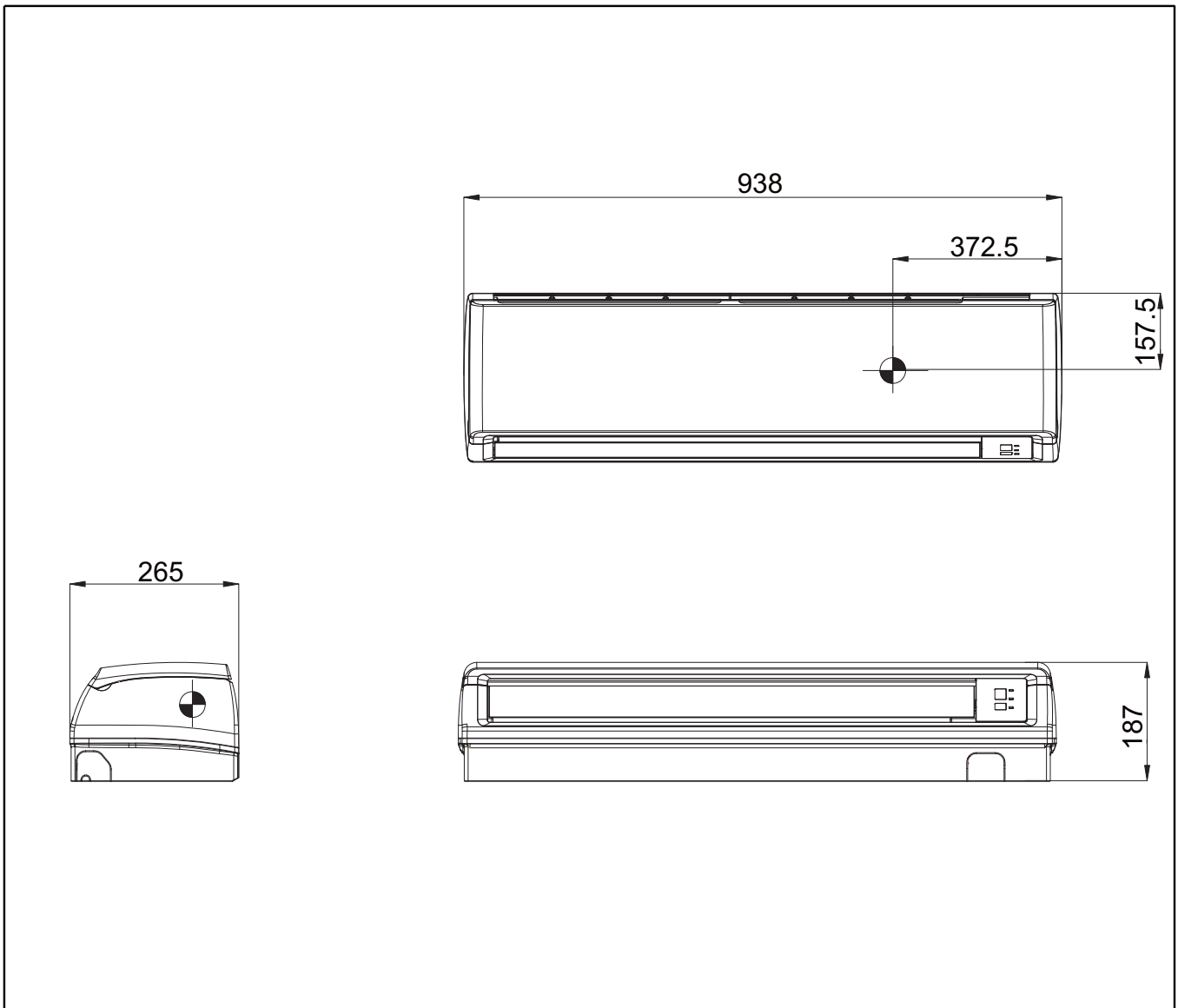

Outdoor unit

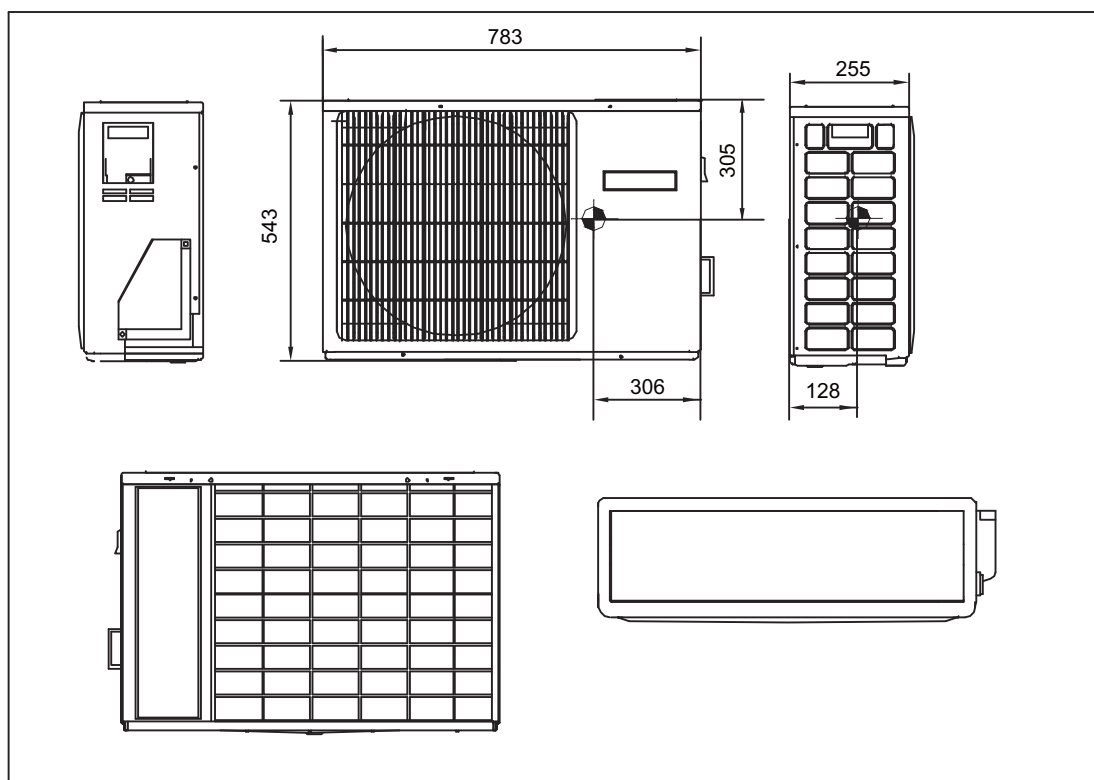

10.5 Operation range

The name of parts

Cooling

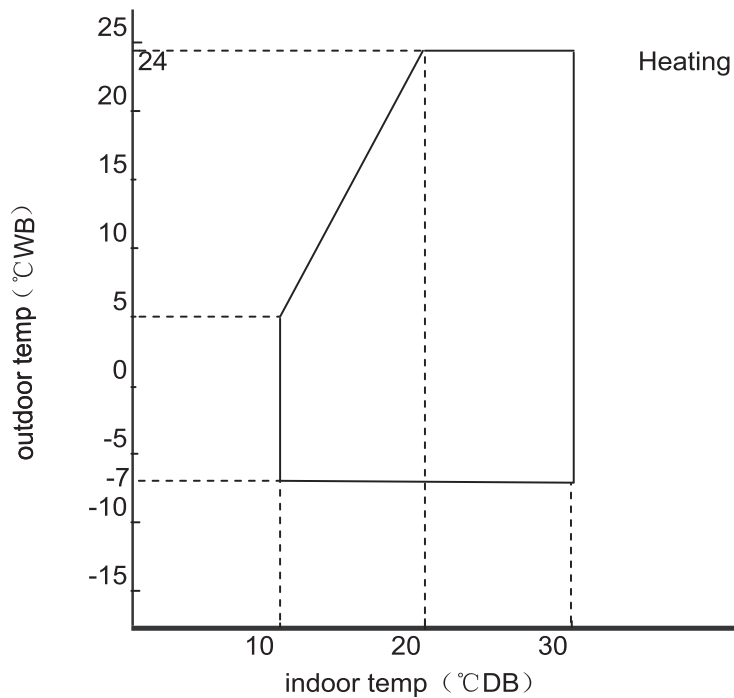
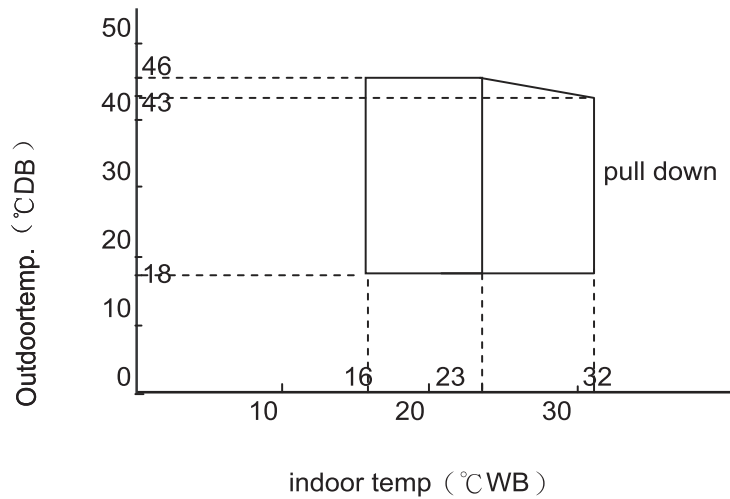

Notes:

The graphs are based on the following condition:

Equivalent piping length	7.5m
Level difference	0m
Air flow rate	high

10.6 Accessories

Standard name	HSU-18HEK03
Drain hose	1
Plastic bag	1
screw assembly	1
Air purifier	2
Change for fresh airtube(suit)	0
Mounting plate	1
Remote controller	1
Installation manual	1
Operation manual	1
R-03 dry battery	2
Steel nail	6
Plastic cap	4
Cover	1
Cushion	4
Pipe supporting plate	1
Drain elbow	1

10.7 Description of the unit model's coding rules

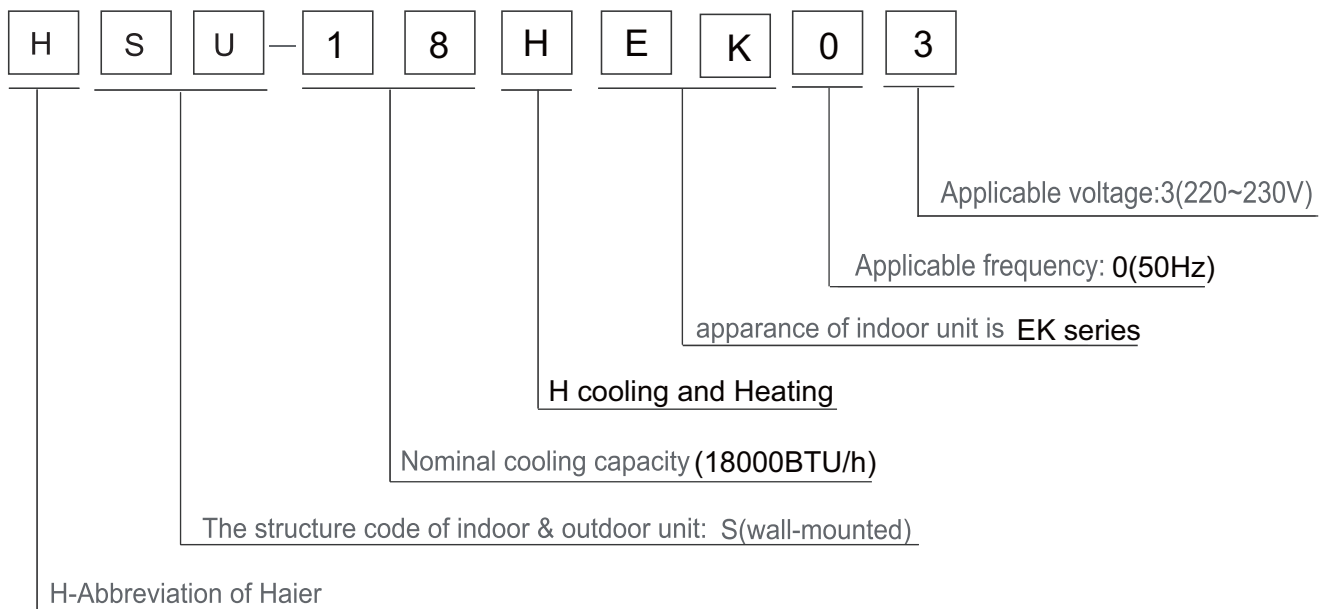

Examples:

HSU-07RD03/R1, It represents wall-mounted split type heat pump air conditioner. The cooling capacity is 7000BTU/h, and the power supply is 220-230V/50Hz, "D" means the developing sequence, and "R1" means the refrigerant is R407C.

11. Removal Procedure

Indoor unit

11.1 Removal of Air Filter

Procedure

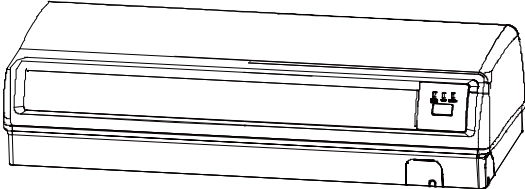
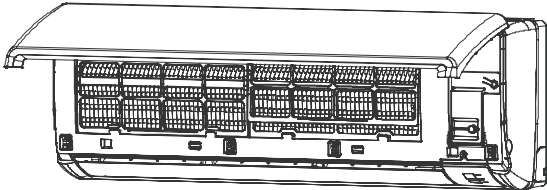

Warning Be sure to wait 10 minutes or more after turning off all power supplies before disassembling work.

Step	Procedure	Points
1. Features		
2. Remove the air filters.	<p data-bbox="167 1099 469 1218">1 Hold the front panel by the tabs on the both sides and lift it until it stops with a click.</p> 	

Step	Procedure	Points
2	Lift an air filter upwards slightly and then pull it out downwards.	<ul style="list-style-type: none">■ Please embed the air filters into the unit along the grooves as installation.■ Please embed the hooks on air filter completely into the unit during installation.

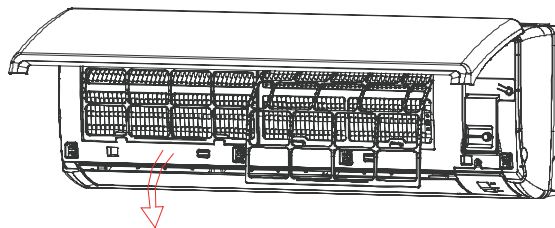
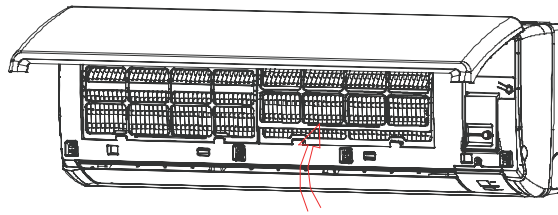
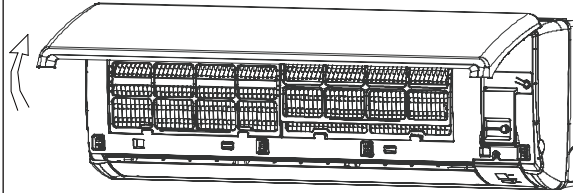

11.2 Removal of Front Panel

Procedure



Warning Be sure to wait 10 minutes or more after turning off all power supplies before disassembling work.

Step	Procedure	Points
1. Remove the front panel.		<ul style="list-style-type: none"> ■ Please close the panels before start the removal procedure of front grille. ■ Slide the front panel from one side to another to release each axis. ■ When assembling, align the right and left axes with grooves in turn and insert them to the end.

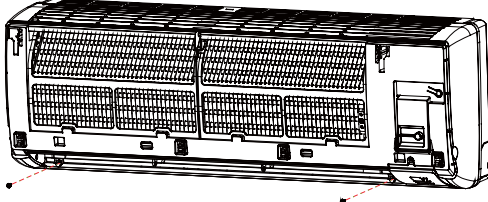
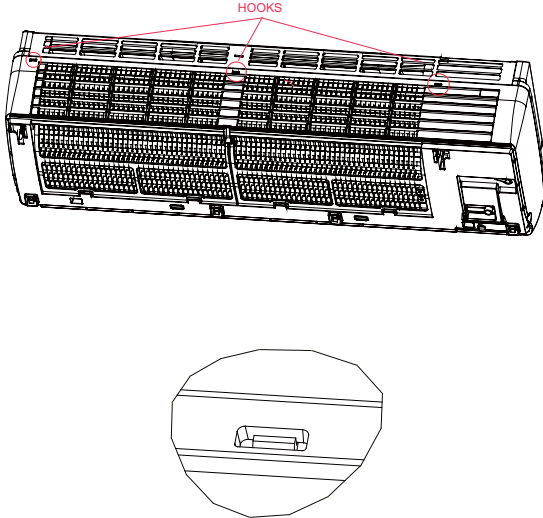
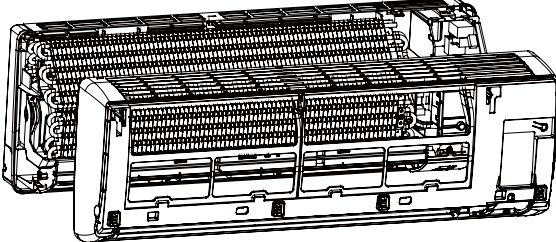
Step		Procedure	Points
2	Loosen the marked two screws		
3	Release the marked three hooks.		
4	Pull the front grille out horizontally and remove it.		<ul style="list-style-type: none"> ■ When assembling, install the front grille horizontally so as not to stuff the flap inside. ■ When assembling, make sure the three hooks are caught properly.

11.3 Removal of horizontal flap

Procedure



Warning Be sure to wait 10 minutes or more after turning off all power supplies before disassembling work.

Step	Procedure	Points
1. Remove the horizontal		<ul style="list-style-type: none"> ■ The horizontal flap is single.
1 Release the center pivot.		<ul style="list-style-type: none"> ■ Installation procedure <ol style="list-style-type: none"> 1. Since key pattern hook is provided, rotate the flap and fit it to the left pivot first. 2. Fit the flap to the right pivot. 3. Fit the flap to the center pivot.
2 Bend the horizontal blade slightly and remove it.		

11.4 Removal of Drain pan

Procedure

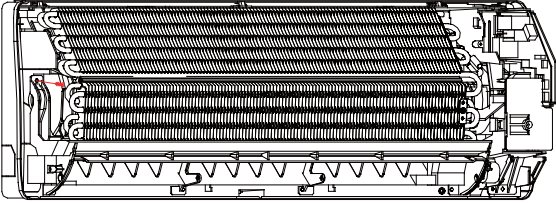
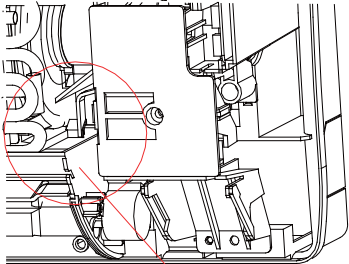
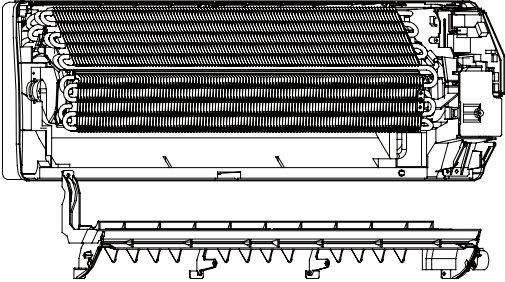

Warning Be sure to wait 10 minutes or more after turning off all power supplies before disassembling work.

Step	Procedure	Points
1. Remove the Drain pan	 <p data-bbox="181 757 448 846">1 Loosen the marked screws under the screw covers</p>  <p data-bbox="181 1043 485 1167">2 Lift up the lower part of the grille to release the hook on the upper backside.</p> <p data-bbox="820 1227 970 1294">hook</p>  <p data-bbox="181 1420 496 1576">3 Rotate the upper part of the grille to release the hook on the lower back side. Pull out the drain pan</p>	

11.5 Removal of Vertical Blades and Swing Motor

Procedure



Warning Be sure to wait 10 minutes or more after turning off all power supplies before disassembling work.

Step	Procedure	Points
<p>■ Remove the assembly of the outlet grille.</p>		
<p>1. Remove the vertical blades.</p>		
<p>1 Push the hooks on the back of the vertical blades and remove.</p>		

11.6 Removal of Electrical Box

Procedure



Warning Be sure to wait 10 minutes or more after turning off all power supplies before disassembling work.

Step	Procedure	Points
<p>■ Remove the front grille.</p>		
<p>1. Remove the electrical box.</p>		
1	<p>Loosen the screw of the drip proof plate.</p>	<p>■ Discharge the static electricity from your body before touching the electrical parts like signal receiver PCB. It may cause malfunction of PCB.</p>
2	<p>Lift and remove the electrical box.</p>	<p>■ When assembling, insert the left hook of the drip proof plate into the hem plate of the heat exchanger.</p>

11.7 Removal of Heat Exchanger

Procedure

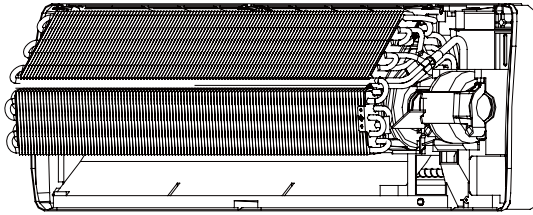
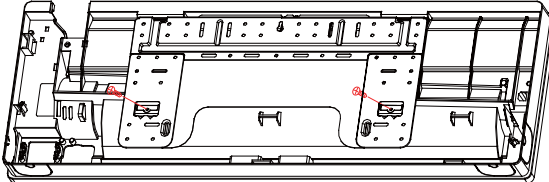
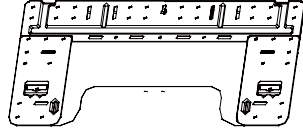
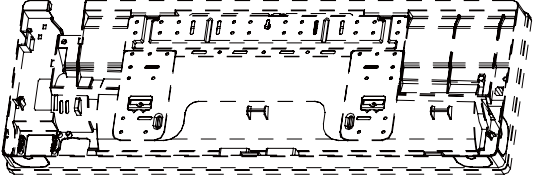

Warning Be sure to wait 10 minutes or more after turning off all power supplies before disassembling work.

Step	Procedure	Points
		<ul style="list-style-type: none"> ■ You can detach the indoor unit without removing the assembly of the outlet grille.
1	Loosen the screws fixed to the installation plate. 	<ul style="list-style-type: none"> ⚠ Caution If gas leaks, repair the spot of leaking, then collect all refrigerant from the unit. After conducting vacuum drying, recharge proper amount of refrigerant.
2	Loosen the marked hooks 	<ul style="list-style-type: none"> ⚠ Caution Do not contaminate any gas (including air) other than the specified refrigerant (R410A), into refrigerant cycle. (Contaminating of air or other gas causes abnormal high pressure in refrigerating cycle, and this results in pipe breakage or personal injuries.)
3	Loosen the marked screws and remove mounting plate  	<ul style="list-style-type: none"> ■ Pay attention so that the residual water in the drain will not make the floor wet. ■ In case that a drain hose is buried inside a wall, remove it after the drain hose in the wall is pulled out. ■ Use two wrenches to disconnect pipes. ■ When disconnecting pipes, cover every nozzle with caps so as not to let dust and moisture in.

Step	Procedure	Points
1	Release the hooks	
2	Release the hook from the back side. Lift up the lower part of the fixture plate and remove it.	
6	Remove the heat exchanger	

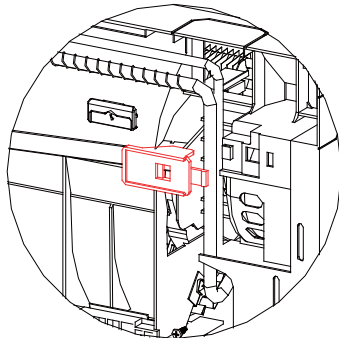
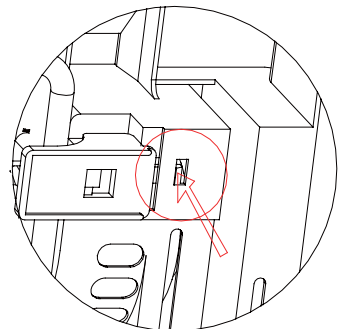
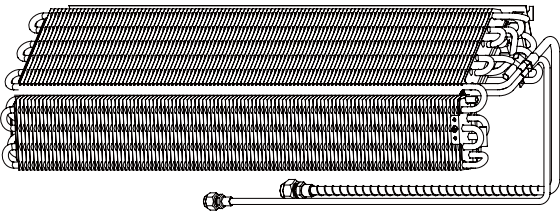
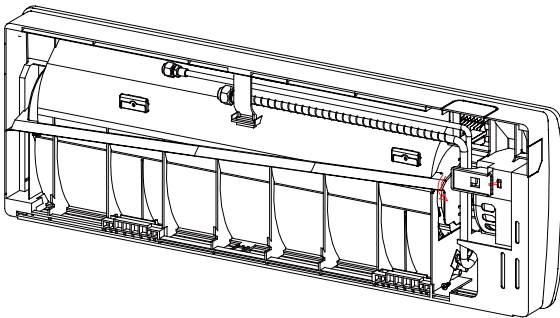
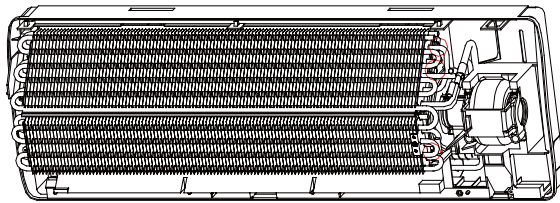
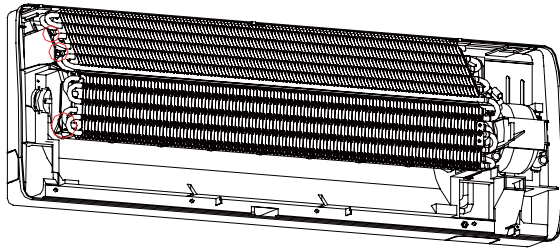

11.8 Removal of Fan Rotor and Fan Motor

Procedure



Warning Be sure to wait 10 minutes or more after turning off all power supplies before disassembling work.

Step	Procedure	Points
1. Remove the right side plate.		
1 Loosen the 2 screws.		
2 Remove the fixing plate.		

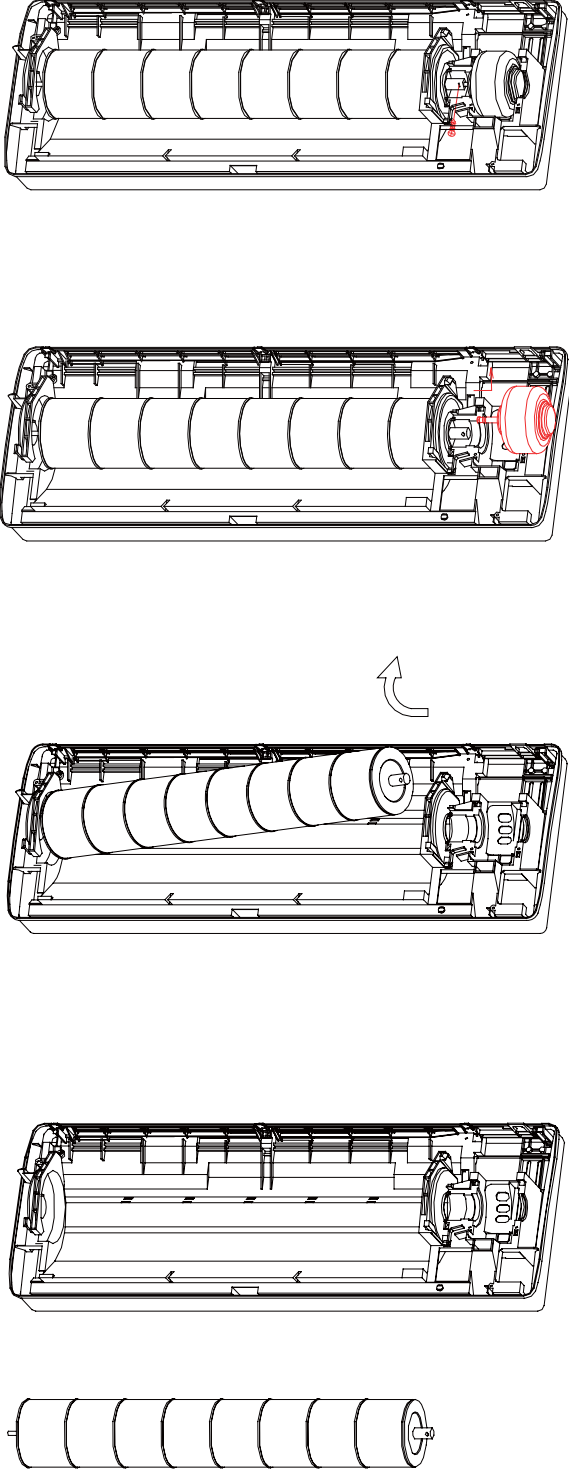
Step	Procedure	Points
3. Remove the fan.		
1	Loosen the marked screw.	
2	Lift up the right part of the fan motor and slide it to the rightward to remove.	
3	Lift up the right part of the fan and remove it	
		

11.9 Removal of Outdoorunit

Procedure



Warning Be sure to wait 10 minutes or more after turning off all power supplies before disassembling work.

Step	Procedure	Points
1. Features		<ul style="list-style-type: none"> ■ Be careful not to cut your finger by the fins of the heat exchanger.
<p>1 Loosen the screw of the stop valve cover. Pull down the stop valve cover and remove it.</p>		<ul style="list-style-type: none"> ■ The stop valve cover is united with the shelter. ■ When assembling, make sure to fit the 5 hooks.

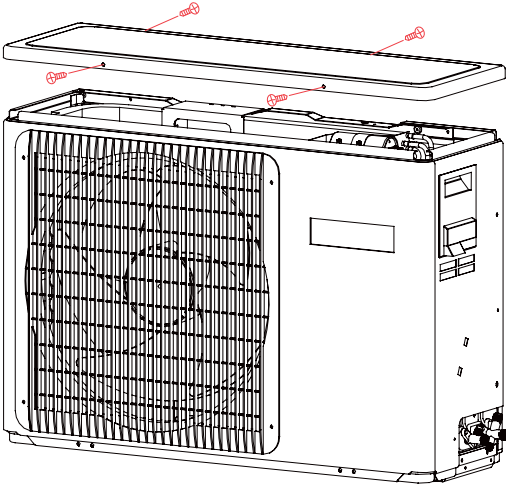
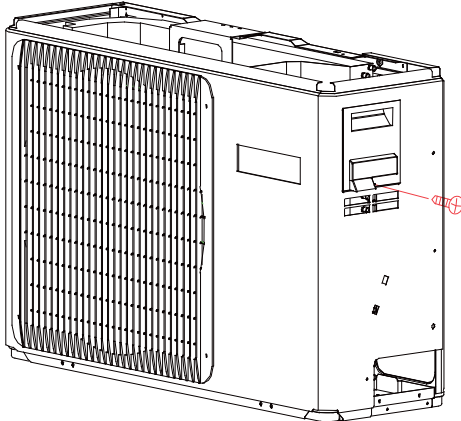
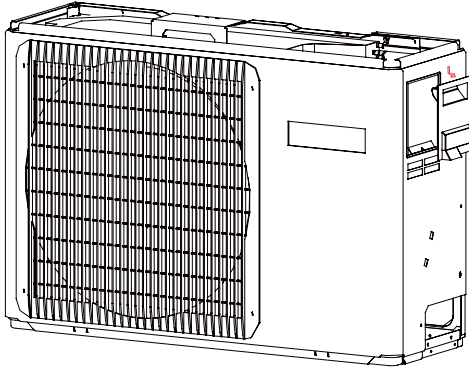
Step	Procedure	Points
2. Remove the panels.		
1 Loosen the 4 screws and lift the top panel		
2 Loosen the service cover screw and remove the service cover.		

Step	Procedure	Points
3	Loosen the screws of the panel.	

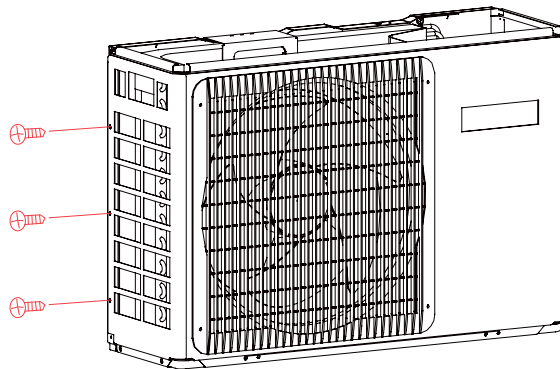
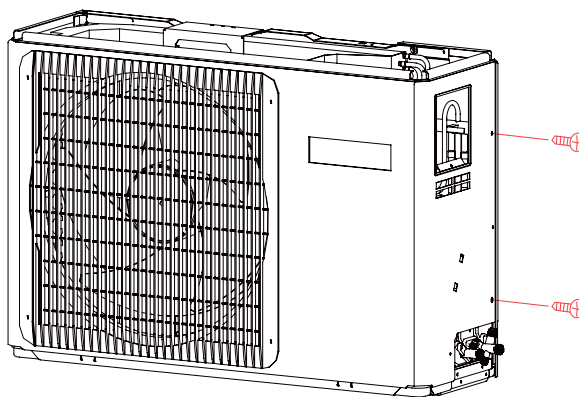
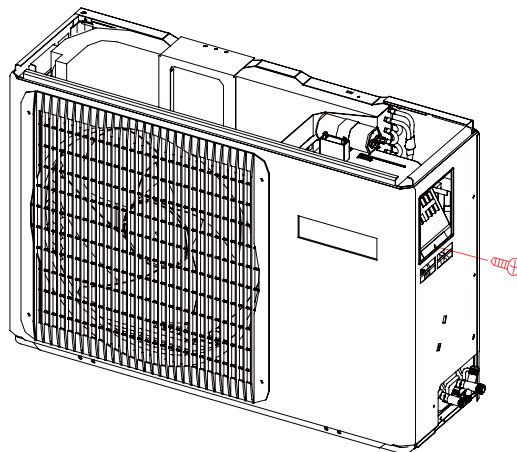

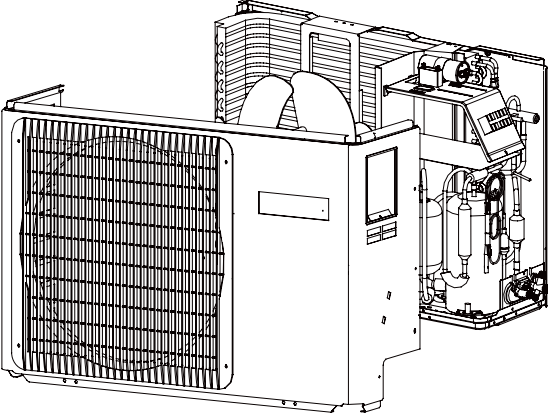
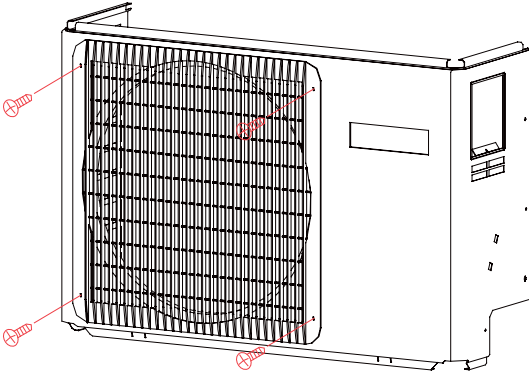
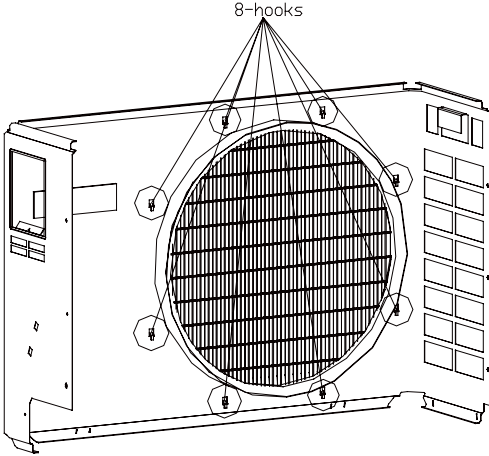
Step	Procedure	Points
4	Pull and remove the front panel.	
3. Remove the outlet grille		
1	Unscrew the four marked screws	
2	Push the eight hooks on the inside back of front panel, then pull the outlet grille off.	
		
	 <p>8-hooks</p>	

Procedure



Warning Be sure to wait 10 minutes or more after turning off all power supplies before disassembling work.

Step	Procedure	Points
<p>1 Remove the fixing screws Then lift the electrical box</p>		

Procedure

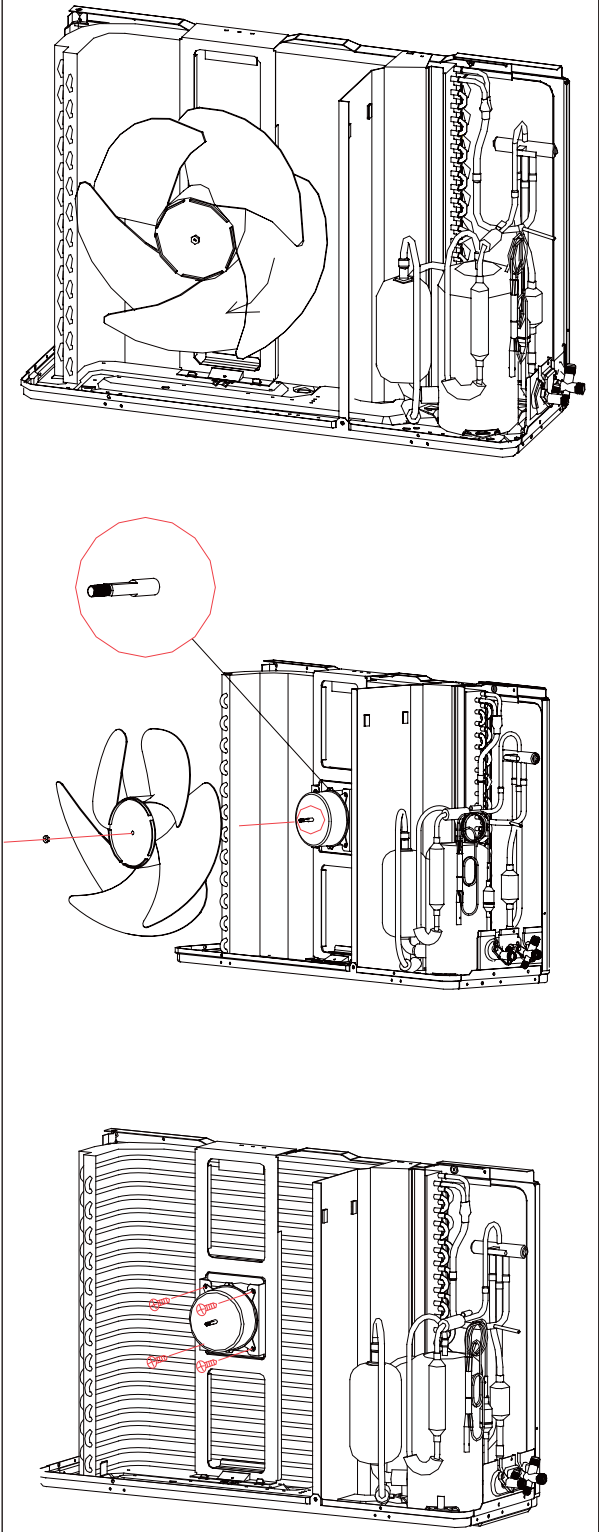
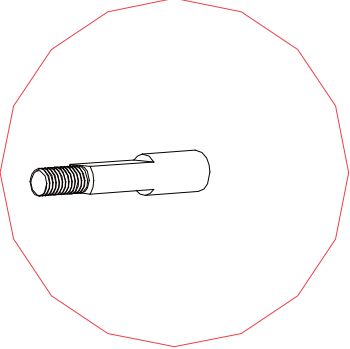

Warning Be sure to wait 10 minutes or more after turning off all power supplies before disassembling work.

Step	Procedure	Points
1	<p data-bbox="228 1104 496 1167">Loosen the fixing screw and remove the fan</p> 	 <ul style="list-style-type: none"> <li data-bbox="1106 1435 1461 1597">■ Put the lead wire through the back of the motor when assembling. (so as not to be entangled with the propeller fan)

Procedure

 **Warning** Be sure to wait 10 minutes or more before disassembling work.

Step	Procedure	Points
1	Loosen the fixing screws and lift the fan motor bracket .	

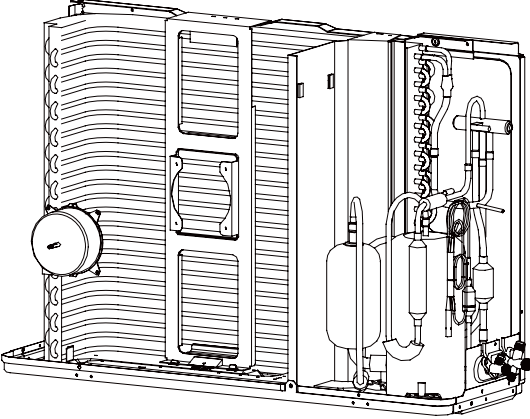

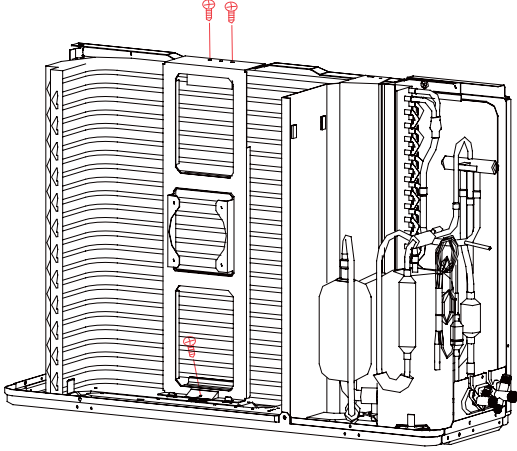

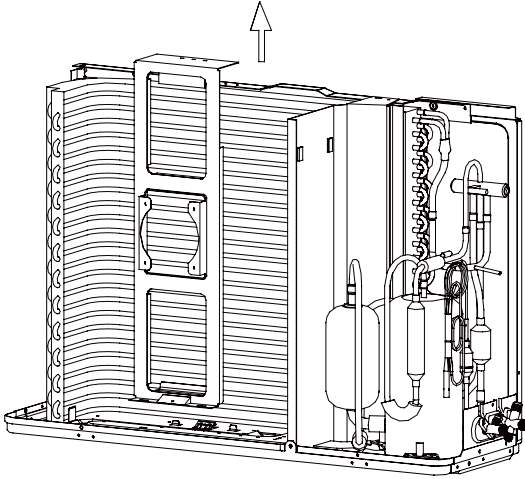

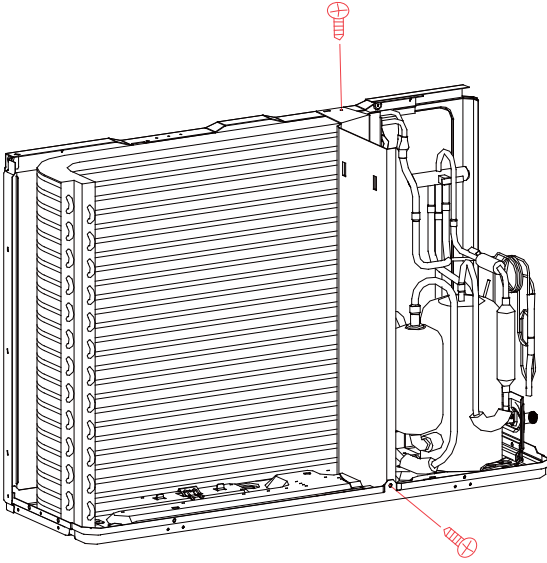
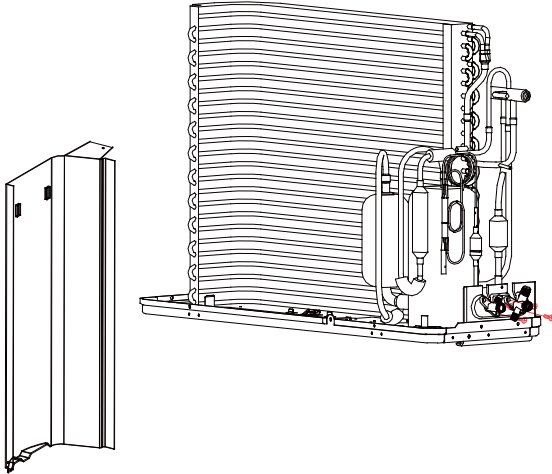
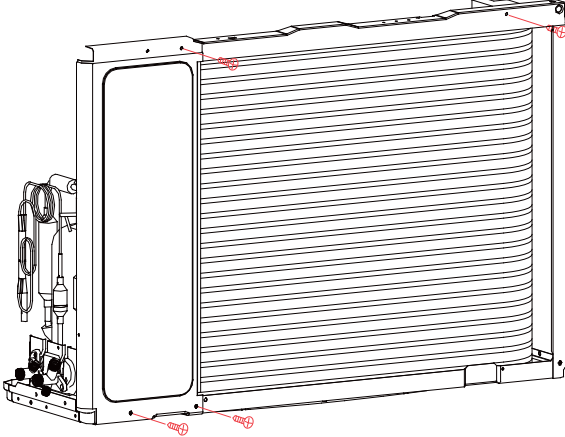
Step	Procedure	Points
3	<p>Loosen the 2 screws</p> 	
4	<p>The partition plate has a hook on the lower side. Lift and pull the partition plate to remove.</p> 	<p>■ When assembling ,fit the lower hook into the bottom frame .</p>
5	<p>Loosen the marked fixing screws</p> 	

Procedure

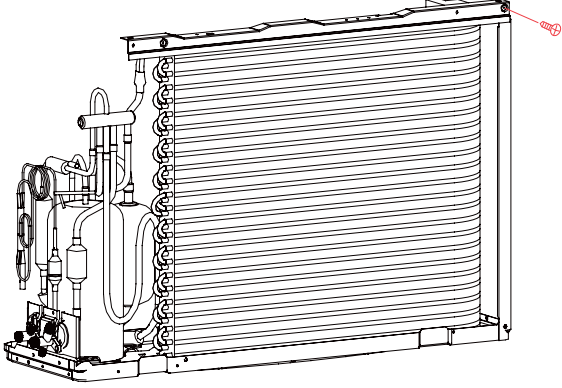
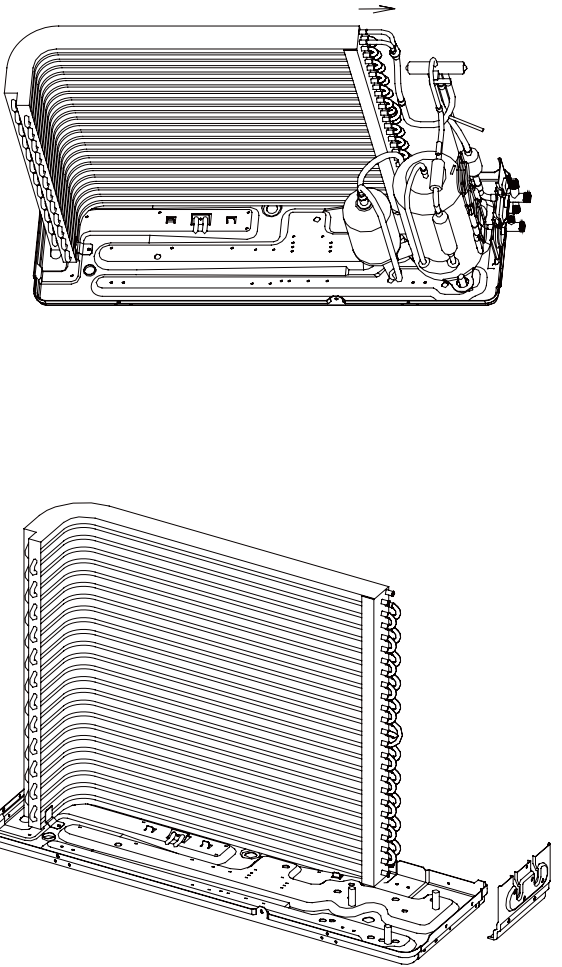

Warning Be sure to wait 10 minutes or more after tu
before disassembling work.

Step	Procedure	Procedure	Points
1	Loosen the marked screw .		
2	Cut down the connecting pipe and pull out the compressor and remove the valve bracket .		

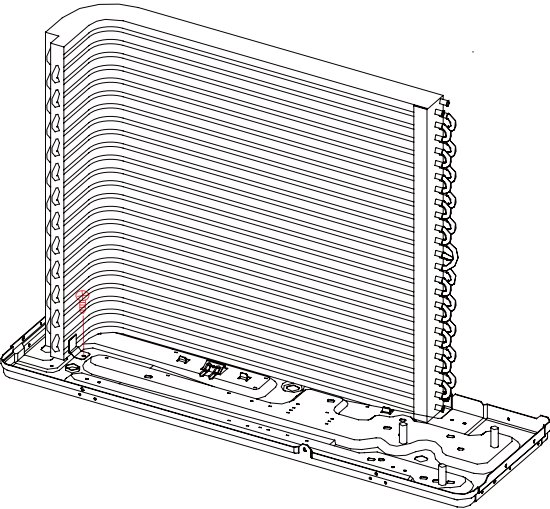
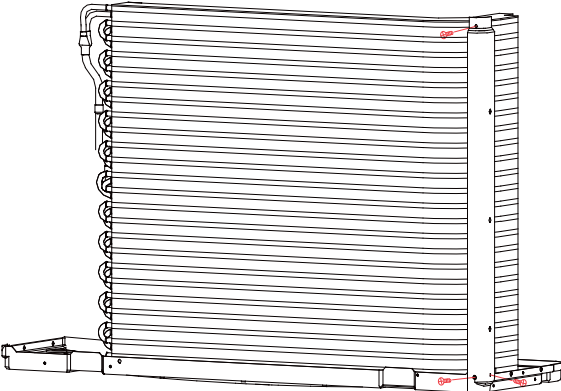
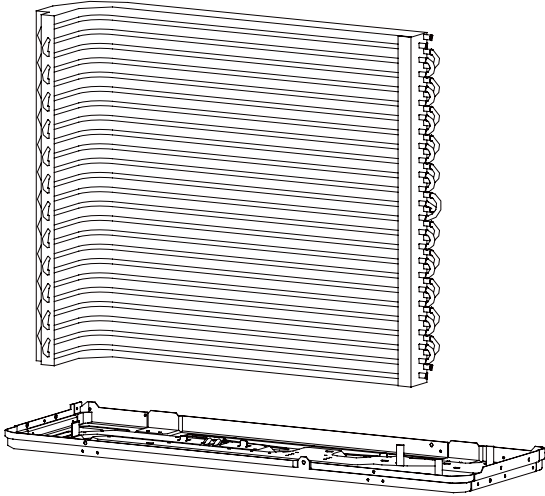
Step	Procedure	Points
3	Loosen the marked fixing screw .	
		
4	Loosen the fixing hook and remove the heat exchanger .	
		
		

Sincere Forever

Haier Group

Haier Industrial Park, No.1, Haier Road

266101, Qingdao, China_

E-mail: hractech@haier.com

Tel: +86 532 87636960

[Http://www.haier.com](http://www.haier.com)

Edited by : Liu Tao
Zhang Jing

Signed by : Yang Bifei

Approved by: Wu Hongjin



Большая библиотека технической документации

<https://splitsystema48.ru/instrukcii-po-ekspluatacii-kondicionerov.html>

каталоги, инструкции, сервисные мануалы, схемы.